

**30809-672 HF FRAME TYPE PLUG-IN UNIT BODY TUBE, 21 HP, FOR 220 MM DEEP PCB**

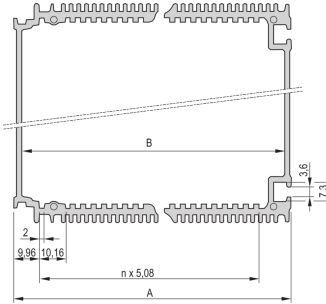
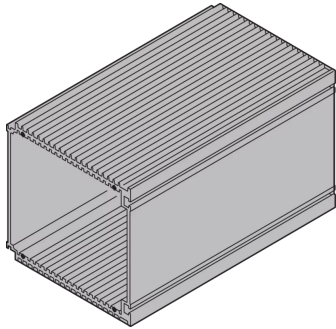

**KEY FEATURES**

The black HF body tube, for HF frame-type plug-in unit enables a user to insert PCBs

The tube offers a shielding against high-frequency radiation

Module body with cooling Fins

Plug-in unit can be mounted in a subrack or fitted laterally to a mounting plate with the slide nut

**PRODUCT ATTRIBUTES**

Product Type: Cover

Works With: Cassettes

Rack Height: 3 U

Rack Width: 21 HP

Length: 220 mm

Package Quantity: 5

**ADDITIONAL PRODUCT DETAILS**

The black HF body tube, for HF frame-type plug-in unit enables a user to insert PCBs.

Please order front Panel, rear Panel, brackets for PCBs and fixing materials separately.

Please take into consideration that deliveries may be carried out in the stated SPQs (SPQ, e.g. 5 pieces, 10 pieces, 50 pieces, etc.). Differing order quantities (e.g. 2 pieces) may be changed to the next possible delivery quantity = Standard Pack Quantity.



**North America**

All locations  
+1.763.422.2661  
Chat with us:  
[schroff.nvent.com](https://schroff.nvent.com)

**Europe**

Straubenhardt, Germany  
+49.7082.794.0  
Betschdorf, France  
+33.3.88.90.64.90  
Warsaw, Poland  
+48.22.209.98.35  
Assago, Italy  
+39.02.932.7141  
Chat with us:  
[schroff.nvent.com](https://schroff.nvent.com)

**Asia**

Shanghai, China  
+86.21.2412.6943  
Qingdao, China  
+86.532.8771.6101  
Singapore  
+65.6768.5800  
Shin-Yokohama, Japan  
+81.45.476.0271  
Chat with us:  
[schroff.nvent.com](https://schroff.nvent.com)

**Middle East & India**

Dubai, United Arab Emirates  
+971.4.378.1700  
Bangalore, India  
+91.80.6715.2001  
Istanbul, Turkey  
+90.216.250.7374  
Chat with us:  
[schroff.nvent.com](https://schroff.nvent.com)



Our powerful portfolio of brands:  
[nVent.com](https://nVent.com) **CADDY ERICO HOFFMAN RAYCHEM SCHROFF TRACER**