

## 24575-255 COMPACPRO FRONT/REAR PANEL, WITH HIDDEN FIXING, 4 U, 63 HP, 2.5 MM, AL, ANODIZED, UNTREATED EDGES

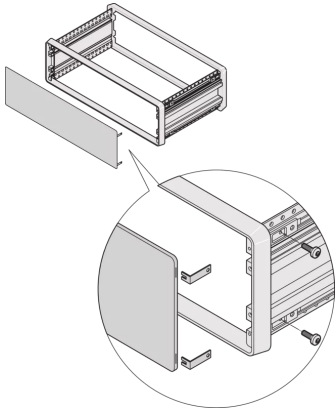

### KEY FEATURES

---

Al panel, 2.5 mm

### PRODUCT ATTRIBUTES

---

Accessory Type: Front panel

Material: Aluminum

Front Finish: Anodized

Rear Finish: Anodized

Treated Edges: No

Rack Height: 4 U

Rack Width: 63 HP

Height: 172.9 mm

Width: 345.4 mm

Depth: 2.5 mm

Package Quantity: 1

## ADDITIONAL PRODUCT DETAILS

---

The front panel for CompacPRO Case mounts to the frame of the case. The front panel has no visible screws and can be used for front foil.

## CERTIFICATIONS

---



### North America

All locations  
+1.763.422.2661  
Chat with us:  
[schroff.nvent.com](https://schroff.nvent.com)

### Europe

Straubenhardt, Germany  
+49.7082.794.0  
Betschdorf, France  
+33.3.88.90.64.90  
Warsaw, Poland  
+48.22.209.98.35  
Assago, Italy  
+39.02.932.7141  
Chat with us:  
[schroff.nvent.com](https://schroff.nvent.com)

### Asia

Shanghai, China  
+86.21.2412.6943  
Qingdao, China  
+86.532.8771.6101  
Singapore  
+65.6768.5800  
Shin-Yokohama, Japan  
+81.45.476.0271  
Chat with us:  
[schroff.nvent.com](https://schroff.nvent.com)

### Middle East & India

Dubai, United Arab Emirates  
+971.4.378.1700  
Bangalore, India  
+91.80.6715.2001  
Istanbul, Turkey  
+90.216.250.7374  
Chat with us:  
[schroff.nvent.com](https://schroff.nvent.com)



Our powerful portfolio of brands:  
[nVent.com](https://nVent.com) **CADDY ERICO HOFFMAN RAYCHEM SCHROFF TRACER**

© 2023 nVent. All nVent marks and logos are owned or licensed by nVent Services GmbH or its affiliates. All other trademarks are the property of their respective owners.

nVent reserves the right to change specifications without notice.