

24575-035 COMPACPRO FRONT/REAR PANEL, WITH HIDDEN FIXING, 2 U, 42 HP, 2.5 MM, AL, ANODIZED, UNTREATED EDGES

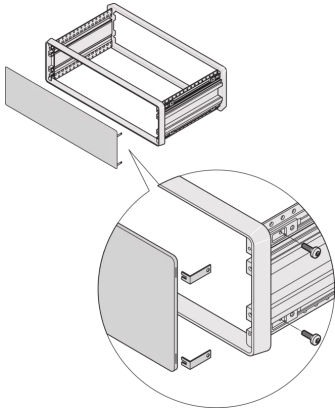

KEY FEATURES

Al panel, 2.5 mm

PRODUCT ATTRIBUTES

Accessory Type: Front panel

Material: Aluminum

Front Finish: Anodized

Rear Finish: Anodized

Treated Edges: No

Rack Height: 2 U

Rack Width: 42 HP

Height: 84 mm

Width: 238.7 mm

Depth: 2.5 mm

Package Quantity: 1

ADDITIONAL PRODUCT DETAILS

The front panel for CompacPRO Case mounts to the frame of the case. The front panel has no visible screws and can be used for front foil.

CERTIFICATIONS



North America

All locations
+1.763.422.2661
Chat with us:
schroff.nvent.com

Europe

Straubenhardt, Germany
+49.7082.794.0
Betschdorf, France
+33.3.88.90.64.90
Warsaw, Poland
+48.22.209.98.35
Assago, Italy
+39.02.932.7141
Chat with us:
schroff.nvent.com

Asia

Shanghai, China
+86.21.2412.6943
Qingdao, China
+86.532.8771.6101
Singapore
+65.6768.5800
Shin-Yokohama, Japan
+81.45.476.0271
Chat with us:
schroff.nvent.com

Middle East & India

Dubai, United Arab Emirates
+971.4.378.1700
Bangalore, India
+91.80.6715.2001
Istanbul, Turkey
+90.216.250.7374
Chat with us:
schroff.nvent.com



Our powerful portfolio of brands:
nVent.com **CADDY ERICO HOFFMAN RAYCHEM SCHROFF TRACER**

© 2023 nVent. All nVent marks and logos are owned or licensed by nVent Services GmbH or its affiliates. All other trademarks are the property of their respective owners.

nVent reserves the right to change specifications without notice.