

23130-225 VARISTAR DECO FRAME ADAPTER BRACKET, 2200H 600W, RAL 7021

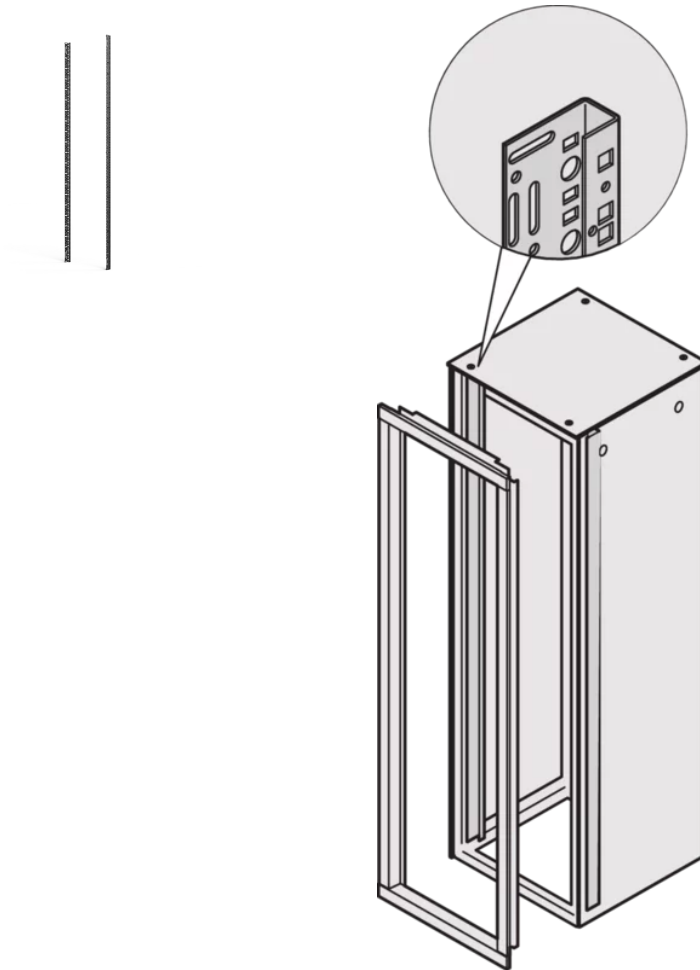

KEY FEATURES

For assembling slide rails and shelves in Varistar Deco

PRODUCT ATTRIBUTES

Product Type: Bracket

Product Family: Varistar

Type: Deco Frame Bracket

Works With: Cabinet; Varistar CP

Material: Steel

Finish: Powder Coated

Color: Black Grey

Color Code: RAL 7021

Rack Height: 47 U

Height: 2200 mm

Width: 600 mm

ADDITIONAL PRODUCT DETAILS

Adapter Brackets are helpful in assembling slide rails and shelves for a nopen frame Varistar cabinet with deco frame.

CERTIFICATIONS



North America

All locations

+1.763.422.2661

Chat with us:

schroff.nvent.com

Europe

Straubenhardt, Germany

+49.7082.794.0

Betschdorf, France

+33.3.88.90.64.90

Warsaw, Poland

+48.22.209.98.35

Assago, Italy

+39.02.932.7141

Chat with us:

schroff.nvent.com

Asia

Shanghai, China

+86.21.2412.6943

Qingdao, China

+86.532.8771.6101

Singapore

+65.6768.5800

Shin-Yokohama, Japan

+81.45.476.0271

Chat with us:

schroff.nvent.com

Middle East & India

Dubai, United Arab Emirates

+971.4.378.1700

Bangalore, India

+91.80.6715.2001

Istanbul, Turkey

+90.216.250.7374

Chat with us:

schroff.nvent.com



Our powerful portfolio of brands:
nVent.com **CADDY ERICO HOFFMAN RAYCHEM SCHROFF TRACER**

© 2023 nVent. All nVent marks and logos are owned or licensed by nVent Services GmbH or its affiliates. All other trademarks are the property of their respective owners.

nVent reserves the right to change specifications without notice.