

22130-578 VARISTAR EMC CONNECTION PLATE, IP55, FLUSH, RAL 7035, 400H
600D

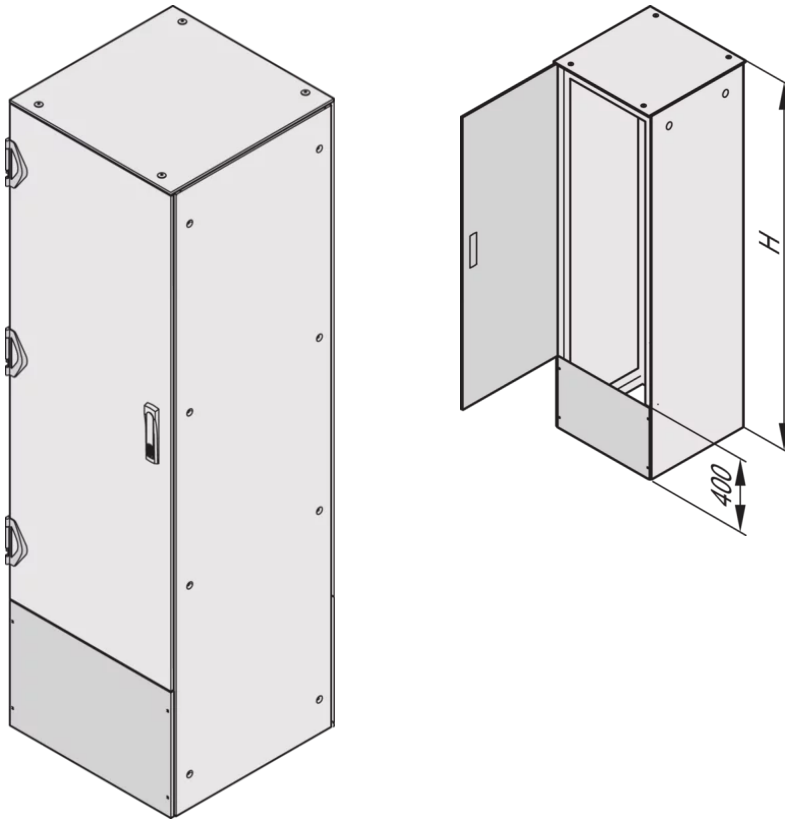

KEY FEATURES

For recessed plate: Plate recessed by 40 mm

Protection class IP-55

Can be fitted top or bottom

As a flat plate or a recessed plate

Height 400 mm

Stainless steel, 1 mm

EMC

PRODUCT ATTRIBUTES

Product Type: Cabinet/Rack Panel

Product Family: Varistar

Type: Filler Panel

Color: Light Grey

Color Code: RAL 7035

Height: 400 mm

Width: 600 mm

ADDITIONAL PRODUCT DETAILS

Varistar EMC Connection Plate for shortened Door/Rear Panel, IP 55 flush.

CERTIFICATIONS



North America

All locations

+1.763.422.2661

Chat with us:

schroff.nvent.com

Europe

Straubenhardt, Germany

+49.7082.794.0

Betschdorf, France

+33.3.88.90.64.90

Warsaw, Poland

+48.22.209.98.35

Assago, Italy

+39.02.932.7141

Chat with us:

schroff.nvent.com

Asia

Shanghai, China

+86.21.2412.6943

Qingdao, China

+86.532.8771.6101

Singapore

+65.6768.5800

Shin-Yokohama, Japan

+81.45.476.0271

Chat with us:

schroff.nvent.com

Middle East & India

Dubai, United Arab Emirates

+971.4.378.1700

Bangalore, India

+91.80.6715.2001

Istanbul, Turkey

+90.216.250.7374

Chat with us:

schroff.nvent.com



Our powerful portfolio of brands:
nVent.com **CADDY ERICO HOFFMAN RAYCHEM SCHROFF TRACER**

© 2023 nVent. All nVent marks and logos are owned or licensed by nVent Services GmbH or its affiliates. All other trademarks are the property of their respective owners.

nVent reserves the right to change specifications without notice.