

22117-777 EURORACK 19" CABINET FRAME, 38 U 600W 900D

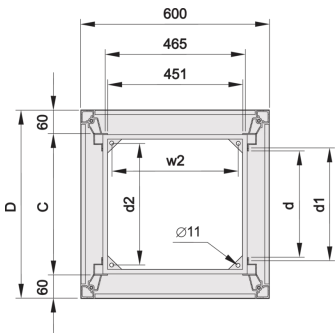
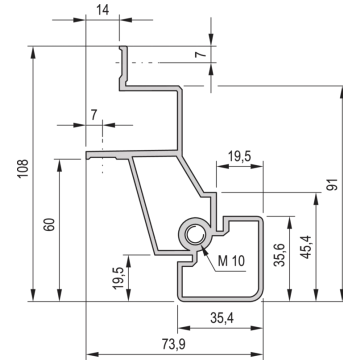
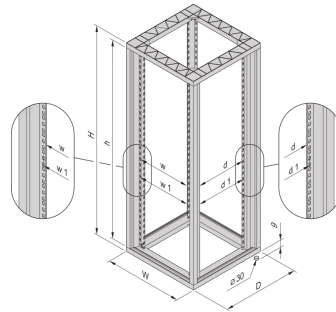
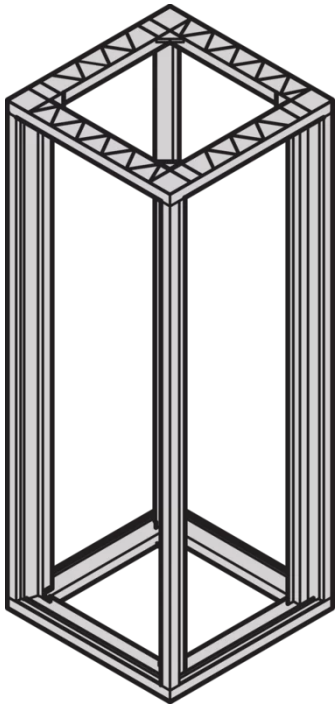

KEY FEATURES

Bolted, frame Al diecast, upright Al extrusion

Fixed spacing between front and rear 19" plane

Finish: RAL 7021

PRODUCT ATTRIBUTES

Product Type: Cabinet/Rack Frame

Product Family: Eurorack

Type: Standard

Frame Material: Aluminum

Color: Black Grey

Color Code: RAL 7021

Rack Height: 38 U

Height: 1798 mm

Width: 600 mm

Depth: 900 mm

Static Load: 400 kg

ADDITIONAL PRODUCT DETAILS

Fixed spacing between front and rear 19" plane.

CERTIFICATIONS



North America

All locations

+1.763.422.2661

Chat with us:

schroff.nvent.com

Europe

Straubenhardt, Germany

+49.7082.794.0

Betschdorf, France

+33.3.88.90.64.90

Warsaw, Poland

+48.22.209.98.35

Assago, Italy

+39.02.932.7141

Chat with us:

schroff.nvent.com

Asia

Shanghai, China

+86.21.2412.6943

Qingdao, China

+86.532.8771.6101

Singapore

+65.6768.5800

Shin-Yokohama, Japan

+81.45.476.0271

Chat with us:

schroff.nvent.com

Middle East & India

Dubai, United Arab Emirates

+971.4.378.1700

Bangalore, India

+91.80.6715.2001

Istanbul, Turkey

+90.216.250.7374

Chat with us:

schroff.nvent.com



Our powerful portfolio of brands:
nVent.com **CADDY ERICO HOFFMAN RAYCHEM SCHROFF TRACER**

© 2023 nVent. All nVent marks and logos are owned or licensed by nVent Services GmbH or its affiliates. All other trademarks are the property of their respective owners.

nVent reserves the right to change specifications without notice.