

20849-357 AIR BAFFLE FOR AMC FILLER MODULE ECO, FULL-SIZE

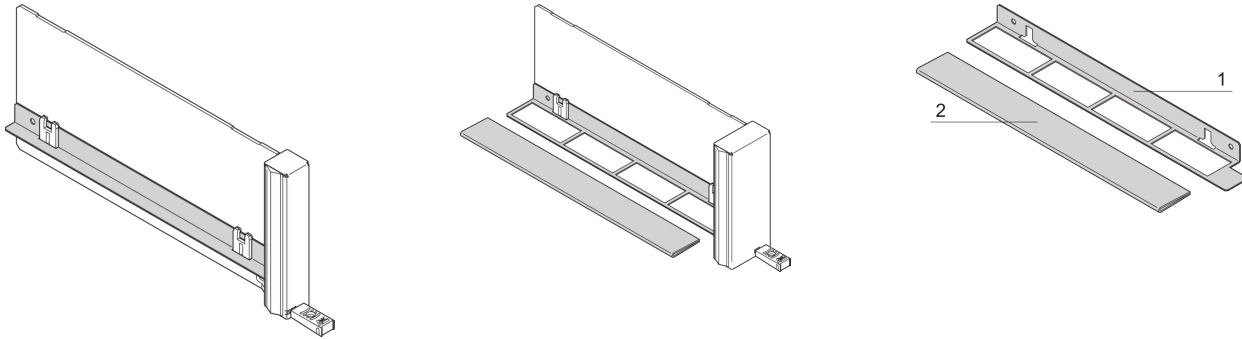

KEY FEATURES

Retrofittable; simply clip onto the PCB of the filler module

To adjust the airflow volume the plastic cover can be individually cut to size (not for compact modules)

PRODUCT ATTRIBUTES

Product Type: Air Baffle

Product Family: MicroTCA

Type: AdvancedMC Filler Module

Works With: Systems

ADDITIONAL PRODUCT DETAILS

Air baffles block airflow in the slot they are installed into, directing air flow to active modules in the system.

CERTIFICATIONS



North America

All locations

+1.763.422.2661

Chat with us:

schroff.nvent.com

Europe

Straubenhardt, Germany

+49.7082.794.0

Betschdorf, France

+33.3.88.90.64.90

Warsaw, Poland

+48.22.209.98.35

Assago, Italy

+39.02.932.7141

Chat with us:

schroff.nvent.com

Asia

Shanghai, China

+86.21.2412.6943

Qingdao, China

+86.532.8771.6101

Singapore

+65.6768.5800

Shin-Yokohama, Japan

+81.45.476.0271

Chat with us:

schroff.nvent.com

Middle East & India

Dubai, United Arab Emirates

+971.4.378.1700

Bangalore, India

+91.80.6715.2001

Istanbul, Turkey

+90.216.250.7374

Chat with us:

schroff.nvent.com



Our powerful portfolio of brands:
nVent.com **CADDY ERICO HOFFMAN RAYCHEM SCHROFF TRACER**

© 2023 nVent. All nVent marks and logos are owned or licensed by nVent Services GmbH or its affiliates. All other trademarks are the property of their respective owners.

nVent reserves the right to change specifications without notice.