

20809-540 FRAME TYPE PLUG-IN UNIT TUBE KIT, SHIELDED, 3 U, 21 HP, 227 MM

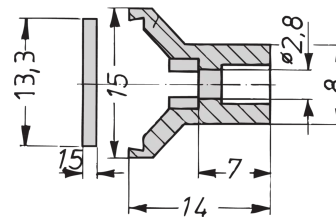
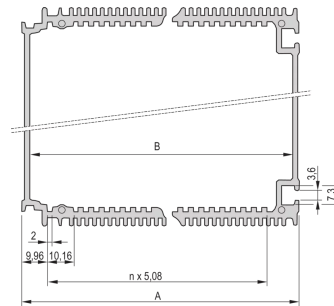
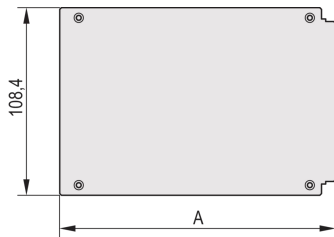
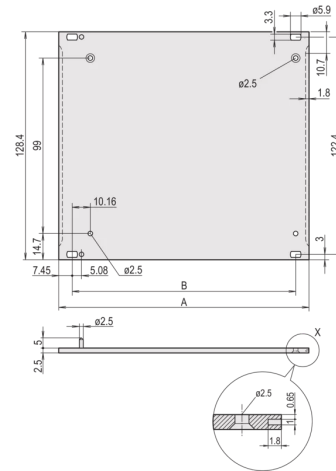
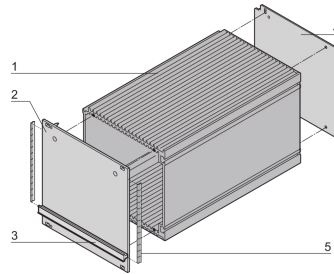

KEY FEATURES

With high shielding from high-frequency radiation

To accept boards in HP grid increments

Solid body (tube) on all sides, with cooling fins

PRODUCT ATTRIBUTES

Product Type: Cassette

Type: High Frequency Frame Type Plug-in Units

Handle Type: Trapezoid

Rack Height: 3 U

Rack Width: 21 HP

Depth: 227 mm

EMC Shielding: Yes

EMC Gasket Type: Stainless Steel

Rear Panel Type: Solid

Cover Plate Type: Tube

Material: Aluminum

Front Finish: Anodized

Rear Finish: Chromated

Cooling: Fins

ADDITIONAL PRODUCT DETAILS

HF Frame type plug-in unit tube, front panel with stainless EMC gaskets.

CERTIFICATIONS



North America

All locations

+1.763.422.2661

Chat with us:

schroff.nvent.com

Europe

Straubenhardt, Germany

+49.7082.794.0

Betschdorf, France

+33.3.88.90.64.90

Warsaw, Poland

+48.22.209.98.35

Assago, Italy

+39.02.932.7141

Chat with us:

schroff.nvent.com

Asia

Shanghai, China

+86.21.2412.6943

Qingdao, China

+86.532.8771.6101

Singapore

+65.6768.5800

Shin-Yokohama, Japan

+81.45.476.0271

Chat with us:

schroff.nvent.com

Middle East & India

Dubai, United Arab Emirates

+971.4.378.1700

Bangalore, India

+91.80.6715.2001

Istanbul, Turkey

+90.216.250.7374

Chat with us:

schroff.nvent.com



Our powerful portfolio of brands:
nVent.com **CADDY ERICO HOFFMAN RAYCHEM SCHROFF TRACER**

© 2023 nVent. All nVent marks and logos are owned or licensed by nVent Services GmbH or its affiliates. All other trademarks are the property of their respective owners.

nVent reserves the right to change specifications without notice.