

20800-278 INTERMEDIATE ADAPTER TO ASSEMBLE SEVERAL 3 U TESTADAPTERS, 6 U, 280 MM, 410 MM

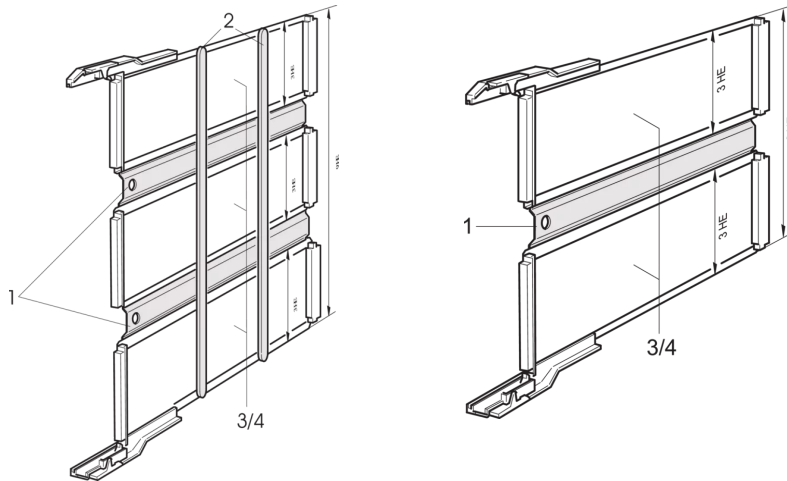

**KEY FEATURES**

Suitable for types B, C, D, E, F

**PRODUCT ATTRIBUTES**

Product Type: Adapter

Works With: Test Adapters

**ADDITIONAL PRODUCT DETAILS**

Bracket kit to make a 6 / 9 U Testadapter from 3 U Testadapters. Suitable for Testadapters with DIN 41612 connectors Type B, C, E and F.

Test adaptor for DIN connector type D cannot be combined with other types.

Test adaptor depth (dimension B) of VMEbus test adaptors on corresponding product page.

Test adaptor depth (dimension B) of type B, C, D, E, F test adaptors on corresponding product page.



**North America**

All locations  
+1.763.422.2661  
Chat with us:  
[schroff.nvent.com](https://schroff.nvent.com)

**Europe**

Straubenhardt, Germany  
+49.7082.794.0  
Betschdorf, France  
+33.3.88.90.64.90  
Warsaw, Poland  
+48.22.209.98.35  
Assago, Italy  
+39.02.932.7141  
Chat with us:  
[schroff.nvent.com](https://schroff.nvent.com)

**Asia**

Shanghai, China  
+86.21.2412.6943  
Qingdao, China  
+86.532.8771.6101  
Singapore  
+65.6768.5800  
Shin-Yokohama, Japan  
+81.45.476.0271  
Chat with us:  
[schroff.nvent.com](https://schroff.nvent.com)

**Middle East & India**

Dubai, United Arab Emirates  
+971.4.378.1700  
Bangalore, India  
+91.80.6715.2001  
Istanbul, Turkey  
+90.216.250.7374  
Chat with us:  
[schroff.nvent.com](https://schroff.nvent.com)



Our powerful portfolio of brands:  
[nVent.com](https://nVent.com) **CADDY ERICO HOFFMAN RAYCHEM SCHROFF TRACER**