



Simply Better Connections

ATEN VanCryst™

**VE819**

HDMI Dongle Wireless Extender  
User Manual

## Compliance Statements

### FEDERAL COMMUNICATIONS COMMISSION INTERFERENCE STATEMENT

This equipment has been tested and found to comply with the limits for a Class B digital service, pursuant to Part 15 of the FCC rules. These limits are designed to provide reasonable protection against harmful interference in a residential installation. Any changes or modifications made to this equipment may void the user's authority to operate this equipment. This equipment generates, uses, and can radiate radio frequency energy. If not installed and used in accordance with the instructions, may cause harmful interference to radio communications. However, there is no guarantee that interference will not occur in a particular installation. If this equipment does cause harmful interference to radio or television reception, which can be determined by turning the equipment off and on, the user is encouraged to try to correct the interference by one or more of the following measures:

- ◆ Reorient or relocate the receiving antenna.
- ◆ Increase the separation between the equipment and receiver.
- ◆ Connect the equipment into an outlet on a circuit different from that to which the receiver is connected.
- ◆ Consult the dealer or an experienced radio/TV technician for help.

The device complies with Part 15 of the FCC Rules. Operation is subject to the following two conditions: (1) this device may not cause harmful interference, and (2) this device must accept any interference received, including interference that may cause undesired operation.

**FCC Caution:** Any changes or modifications not expressly approved by the party responsible for compliance could void the user's authority to operate this equipment.



### KCC Statement

유선 제품용 / B 급 기기 (가정용 방송 통신 기기)  
이 기기는 가정용 (B 급) 전자파적합기기로서 주로 가정에서 사용하는 것을 목적으로 하며, 모든 지역에서 사용할 수 있습니다.

**HDMI Trademark Statement**

The terms HDMI, HDMI High-Definition Multimedia Interface, and the HDMI Logo are trademarks or registered trademarks of HDMI Licensing Administrator, Inc.

**RoHS**

This product is RoHS compliant.

The frequency and maximum EIRP Power in EU are listed as below

Transmitter:

5.19G~5.31GHz:8.29 dBm

5.51G~5.67GHz:8.66 dBm

Receiver:

5.18G~5.24GHz:22.03 dBm

5.19G~5.31GHz:22.88 dBm

5.51G~5.67GHz:22.04 dBm

Operation in the 5.15~5.35GHz band are restricted to indoor usage only.

You are cautioned that changes or modifications not expressly approved by the part responsible for compliance could void the user's authority to operate the equipment.

FCC RF Radiation Exposure Statement:

- 1.This Transmitter must not be co-located or operating in conjunction with any other antenna or transmitter.
- 2.This equipment complies with FCC RF radiation exposure limits set forth for an uncontrolled environment. This equipment should be installed and operated with a minimum distance of 20 centimeters between the radiator and your body.

## About this Manual

---

This User Manual is provided to help you get the most from your system. It covers all aspects of installation, configuration and operation. An overview of the information found in the manual is provided below.

**Chapter 1, Introduction**, introduces you to the VE819 system. Its purpose, features and benefits are presented, and its front and back panel components are described.

**Chapter 2, Hardware Setup**, describes how to set up your installation. Diagrams showing the necessary steps are provided.

**Chapter 3, Basic Operation**, explains the fundamental concepts involved in operating the VE819.

**Chapter 4, OSD Operation**, provides a complete description of the VE819's On-Screen Display (OSD), and how to work with it.

**Chapter 5, Additional Transmitters**, Provides an easy step by step guide to adding additional transmitters.

**An Appendix**, provides specifications and other technical information regarding the VE819.

## Conventions

This manual uses the following conventions:

- |   |  |
|---|--|
| Monospaced  | Indicates text that you should key in.   |
| [ ]   | Indicates keys you should press. For example, [Enter] means to press the <b>Enter</b> key. If keys need to be chorded, they appear together in the same bracket with a plus sign between them: [Ctrl+Alt]. |
| 1.  | Numbered lists represent procedures with sequential steps.   |
| ◆   | Bullet lists provide information, but do not involve sequential steps.   |
| >   | Indicates selecting the option (on a menu or dialog box, for example), that comes next. For example, Start > Run means to open the <i>Start</i> menu, and then select <i>Run</i> .                         |
|  | Indicates critical information.  |

## **VE819 Package Contents**

---

### **VE819**

- ◆ 1 VE819 HDMI Dongle Wireless Transmitter
- ◆ 1 VE819R HDMI Wireless Receiver
- ◆ 1 USB Mini-B to USB Type-A cable
- ◆ 2 USB Mini-B power adapters
- ◆ 1 HDMI cable
- ◆ 1 IR receiver cable
- ◆ 1 user instructions
- ◆ 1 warranty card
- ◆ 1 remote control unit with 2AAA batteries

### **VE819 Transmitter**

- ◆ 1 VE819T HDMI Dongle Wireless Transmitter
- ◆ 1 USB Mini-B to USB Type-A cable
- ◆ 1 USB Mini-B power adapter
- ◆ 1 user instructions
- ◆ 1 warranty card

Check to make sure that all the components are present and that nothing got damaged in shipping. If you encounter a problem, contact your dealer.

Read this manual thoroughly and follow the installation and operation procedures carefully to prevent any damage to the unit, and/or any of the devices connected to it.

## Product Information

---

For information about all ATEN products and how they can help you connect without limits, visit ATEN on the Web or contact an ATEN Authorized Reseller. Visit ATEN on the Web for a list of locations and telephone numbers:

International	<a href="http://www.aten.com">http://www.aten.com</a>
North America	<a href="http://www.aten-usa.com">http://www.aten-usa.com</a>

## User Information

---

### Online Registration

Be sure to register your product at our online support center:

International	<a href="http://eservice.aten.com">http://eservice.aten.com</a>
---------------	---

### Technical Support

When you contact us, please have the following information ready beforehand:

- ◆ Product model number, serial number, and date of purchase.
- ◆ Your computer configuration, including operating system, revision level, expansion cards, and software.
- ◆ Any error messages displayed at the time the error occurred.
- ◆ The sequence of operations that led up to the error.
- ◆ Any other information you feel may be of help.

### **International**

- ◆ For online technical support – including troubleshooting, documentation, and software updates, go to **<http://eservice.aten.com>**
- ◆ For telephone support, call this number:

International	886-2-8692-6959
China	86-400-810-0-810
Japan	81-3-5615-5811
Korea	82-2-467-6789
North America	1-888-999-ATEN ext 4988 1-949-428-1111

## North America

Email Support		support@aten-usa.com
Online Technical Support	Troubleshooting Documentation Software Updates	<a href="http://www.aten-usa.com/support">http://www.aten-usa.com/support</a>
Telephone Support		1-888-999-ATEN ext 4988

## User Notice

All information, documentation, and specifications contained in this manual are subject to change without prior notification by the manufacturer. The manufacturer makes no representations or warranties, either expressed or implied, with respect to the contents hereof and specifically disclaims any warranties as to merchantability or fitness for any particular purpose. Any of the manufacturer's software described in this manual is sold or licensed *as is*. Should the programs prove defective following their purchase, the buyer (and not the manufacturer, its distributor, or its dealer), assumes the entire cost of all necessary servicing, repair and any incidental or consequential damages resulting from any defect in the software.

The manufacturer of this system is not responsible for any radio and/or TV interference caused by unauthorized modifications to this device. It is the responsibility of the user to correct such interference.

The manufacturer is not responsible for any damage incurred in the operation of this system if the correct operational voltage setting was not selected prior to operation. **PLEASE VERIFY THAT THE VOLTAGE SETTING IS CORRECT BEFORE USE.**

# Contents

---

Compliance Statements . . . . .	ii
About this Manual . . . . .	iv
Conventions . . . . .	iv
VE819 Package Contents . . . . .	v
VE819 . . . . .	v
VE819 Transmitter . . . . .	v
Product Information . . . . .	vi
User Information . . . . .	vi
Online Registration . . . . .	vi
Technical Support . . . . .	vi
International . . . . .	vi
North America . . . . .	vii
User Notice . . . . .	vii
Contents . . . . .	viii
<b>1. Introduction</b>	
Overview . . . . .	1
Features . . . . .	2
Requirements . . . . .	3
Display . . . . .	3
Sources . . . . .	3
Components . . . . .	4
VE819T Top and Side View . . . . .	4
VE819R Top View . . . . .	5
IR Remote Control . . . . .	6
<b>2. Hardware Setup</b>	
Wall Mounting . . . . .	8
Setup the Wireless HDMI Transmitter and Receiver . . . . .	9
<b>3. Basic Operation</b>	
Overview . . . . .	11
Transmitter and Receiver Link . . . . .	11
Computer Display Settings . . . . .	12
LED Display . . . . .	12
LED Display Notes . . . . .	13
Powering Off and Restarting . . . . .	13
<b>4. OSD Operation</b>	
Overview . . . . .	15
OSD Main Interface . . . . .	15
Setup Mode . . . . .	15
Pairing Transmitter to Receiver . . . . .	16



Switching between Wireless HDMI Transmitters . . . . .	16
Remove Transmitter . . . . .	16
Modify Transmitter Name . . . . .	17

## **5. Additional Transmitters**

Overview . . . . .	19
Adding New Transmitters . . . . .	19
Pairing Mode for Transmitters . . . . .	19
Pairing Mode for the Receiver: . . . . .	20

## **Appendix**

Safety Instructions . . . . .	21
Specifications . . . . .	23
Supported Video and Audio Formats . . . . .	25
Troubleshooting . . . . .	26
Wall Placement Template . . . . .	28
Limited Warranty . . . . .	29

This Page Intentionally Left Blank

# Chapter 1

## Introduction

### Overview

---

The VE819 HDMI Dongle Wireless Extender is a wireless solution that can extend crystal clear image quality from laptops, DVD players, projectors and other HDMI Devices to HDMI displays, making it perfect for home, office or school. It is capable of streaming full 1080p resolution with 5.1 digital audio support and 3D technology up to 10m\* (33 ft.). A total of three extra transmitters can be paired with the receiver; allowing users to have four source devices paired concurrently. Users can switch between source devices from the receiver side using the IR remote control. By simply connecting the transmitter and receiver to the HDMI source and display with no hardware setup, this allows you to control and design you own custom wireless entertainment space.

---

**Note:** Distance, quality and signal may vary depending on the environment; solid structures, such as steel, concrete and brick may result to shorter distance coverage or complete loss of signal.

---

## Features

---

- ◆ Supports wireless transmission of full uncompressed 1080p HD, 3D videos up to 10 m in a line-of-sight
- ◆ Allows you to switch and independently select any of sources. When additional transmitters are connected
- ◆ Supports audio formats – digital audio LPCM 7.1 channels, Dolby Digital and DTS Digital 5.1 channels
- ◆ Wireless extend or mirror the computer or laptop
- ◆ Superior video quality – 480p, 720p, 1080i, 1080p (24 / 30 / 60fps)
- ◆ Based on WHDI™ technology – Low latency < 1 ms. WHDI enables delivery of uncompressed high-definition digital video over a wireless radio channel connecting any video source to any compatible display device.
- ◆ Secure data transmission – AES 128-bit encryption
- ◆ HDCP compliant
- ◆ Plug and Play, no software or driver installation needed
- ◆ Add up to 4 Wireless HDMI Transmitters

---

### Note:

- ◆ For optimal video quality, the transmission distance shall not exceed 7 m. The true effective transmission distance may vary depending on the installation site; solid obstacles such as steel, concrete, and brick may affect transmission quality and shorten its effective distance.
  - ◆ Additional wireless transmitters are sold separately.
-

## **Requirements**

---

### **Display**

- ◆ A display device with an HDMI Type-A input connector

### **Sources**

- ◆ A source player with an HDMI Type-A output connector

## Components

### VE819T Top and Side View

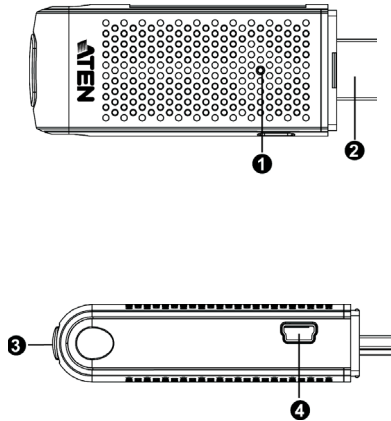

No.	Component	Description
1	status LED	Solid blue when powered on and wireless link is established. <ul style="list-style-type: none"> <li>◆ 1 flash/sec when in pairing mode.</li> <li>◆ 3 flashes/sec when establishing the link with the Receiver.</li> </ul>
2	HDMI connector	Connects the HDMI transmitter to a laptop or media player's HDMI port.
3	info pairing button	Press to show information on the screen. See <i>OSD Operation</i> , page 15
4	USB Mini-B power jack	If used with a computer, connect the USB Mini-B or USB Type-A cable from the transmitter to a USB port on the computer. Or users can connect to a mini USB power adapter.

## VE819R Top View

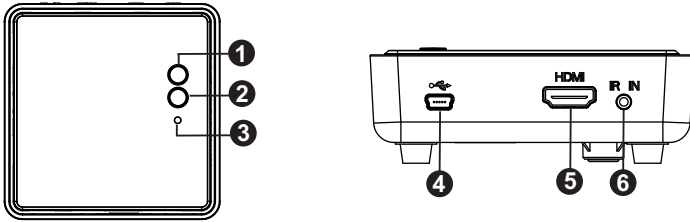

No.	Component	Description
1	power button with LED	<ul style="list-style-type: none"> <li>◆ Press this button to power on / off the VE819 R</li> <li>◆ This LED lights blue to indicate active connection to a source.</li> <li>◆ Lights red when in Standby Mode.</li> </ul>
2	info button	Press to show information on screen. See <i>OSD Operation</i> , page 15.
3	video status LED	<ul style="list-style-type: none"> <li>◆ a. Blinks quickly when there's no input from a selected source.</li> <li>◆ b. Blinks slowly when the video format is not recognized.</li> <li>◆ c. Static blue when the video format is recognized.</li> </ul>
4	USB Mini-B power jack	Connect the USB power adapter to the USB Mini-B power jack on the receiver and a wall outlet for power supply.
5	HDMI output port	Use an HDMI cable to connect your HDMI display device to this port.
6	IR port	Connect an IR extender cable to the IR port. Enables increased signal range for the IR remote.

## IR Remote Control

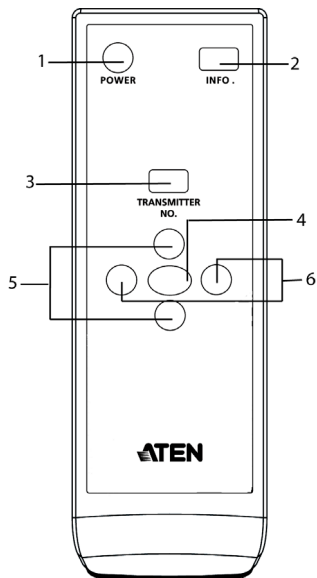

No.	Component	Description
1	power	Press this button to power on / off the receiver.
2	info	Press this button to display the OSD on the screen.
3	transmitter No.	Press this button to switch to another transmitter, if more than one transmitter is being used and within range.
4	OK	Press OK button to confirm selected commands.
5	Up / Down	Press these buttons to operate the OSD and modify the Transmitter name.
6	Left / Right	Press these buttons to operate the OSD and modify the Transmitter name.

**Note:** The battery compartment is located at the back panel of the IR remote control.



## Chapter 2 Hardware Setup



1. Important safety information regarding the placement of this device is provided on page 21. Please review it before proceeding.
2. Make sure that the power to all devices connected to the installation is turned off. You must unplug the power cords of any computers that have the Keyboard Power On function.

**IMPORTANT:** When installing multiple VE819 units, keep each unit at a distance of 2 m (3.3 ft.) or more to minimize signal interference.

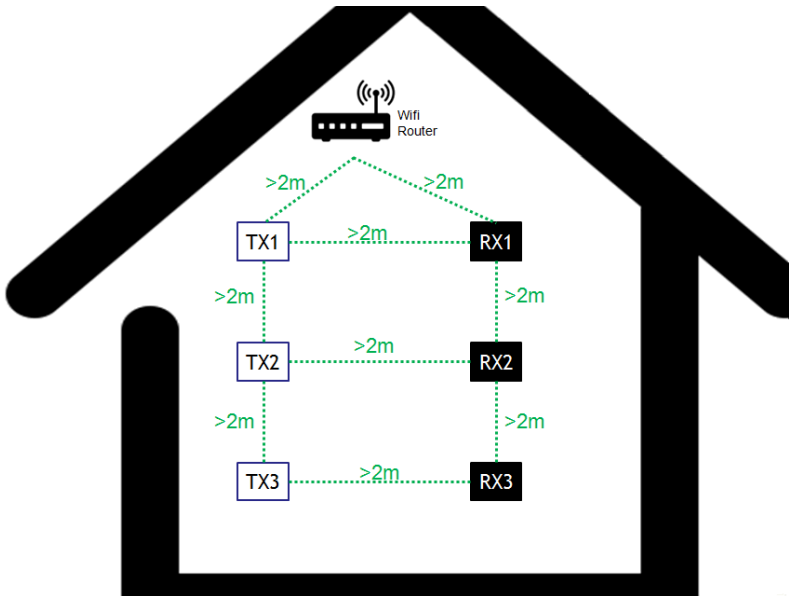

## Wall Mounting

---

For convenience and flexibility, the VE819R can be mounted on the wall. To mount a unit do the following:

1. The paper attached to the appendix(see page 28) illustrates the position of the main holes. Position accordingly and drill two ¼” holes as instructed.

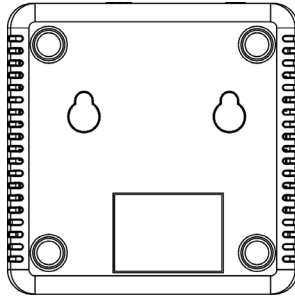

2. Insert anchors into the wall, followed by the screws. Leave 5/8” of the screw protruding for mounting the Receiver.

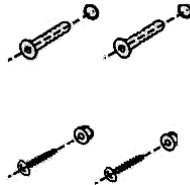

3. Hang the VE819R by having the bottom panel holes aligned into the screws. Slide down into position.

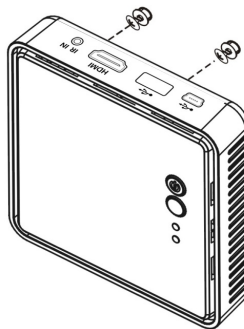

## Setup the Wireless HDMI Transmitter and Receiver

To set up your HDMI Wireless Transmitter and Receiver, please follow these steps:

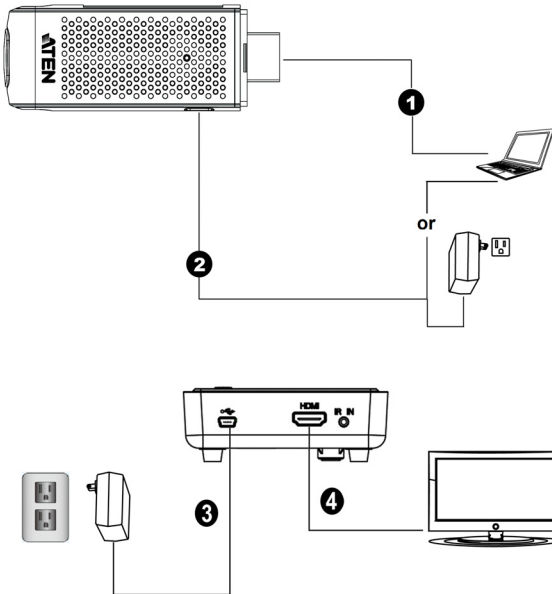

1. Connect the wireless HDMI transmitter to the HDMI port of the computer or media source.
2. Power the transmitter through one of two options:
  - ◆ If used with a Blu-Ray player or similar device, connect the wireless HDMI transmitter to the USB power adapter.
  - ◆ If used with a computer, connect the USB Mini-B to USB Type-A cable from the transmitter to a USB port on the computer.
3. Connect the USB power adapter to the USB Mini-B power jack on the receiver and a wall outlet for power supply.
4. Connect the HDMI cable to the HDMI output port on the receiver and to the HDMI input port on the display.
5. Power on the display. Once the link has been established between the transmitter and receiver, video from the connected computer or HDMI media source will be displayed on the display.

This Page Intentionally Left Blank

# Chapter 3

## Basic Operation

### Overview

---

The VE819 can be operated wirelessly and conveniently to connect your HDMI device to a HDMI display. Transmitters can be managed by using the OSD via the remote control to pair additional transmitters, modify transmitter names, switch between transmitters and remove paired transmitters.

### Transmitter and Receiver Link

---

This section explains how to use your receiver and transmitter. When they are both powered on they can automatically locate each other without installing any other software.

After powering on the Transmitter and Receiver, the panel LEDs blink to indicate that the two units are establishing a connection. This takes around 15 to 20 seconds. The LEDs light a steady blue when the connection is established and the VE819 devices are ready for use. If all operations are normal, the LED lights on both should be static (not blinking).

- ◆ If the LEDs continue to blink after 80 seconds, check the distance between the Transmitter and Receiver. The minimum distance between Transmitter and Receiver is 2 m (6 ft.) while the maximum distance between both Transmitter and Receiver is 10 m (33 ft.).
- ◆ Distance, quality and signal may vary depending on the environment; solid structures, such as steel, concrete and brick may result to shorter distance coverage or complete loss of signal.

## Computer Display Settings

You can adjust your display by going to your computer screen resolution preferences to change the display setting to Duplicate, Extend or Project Only.

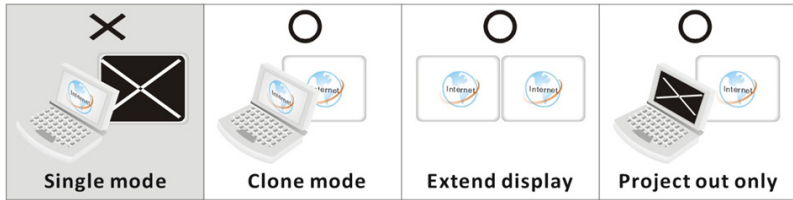

## LED Display

The VE819 has different icons and LED behaviors that display the actions of the transmitter and receiver. These actions are displayed on the OSD display or the devices' LED.

Item / Mode	Status Description	Rx Power LED	Rx Status LED	OSD Display
Standby	For power saving mode.	Static Red	off	
Initial Boot up / Warm up	It will spend 15 ~ 20 seconds for system boot up.	Blinking Blue	Blinking	
Searching available channels	Continuing search available channels If system can't establish link over 80s after initialization. (Note A & D)	Blinking Blue	Blinking	
Wireless linked Mode	No input from selected source (Note B)	Static Blue	Blinking (Quickly)	
	Video format not recognized (Note C)	Static Blue	Blinking (Slowly)	
	Video format is recognized	Static Blue	Static Blue	-

## **LED Display Notes**

- a) If the link has not been established after 80 seconds, it is likely the connection was lost or the transmitter is out of range. You may have to verify the range and adjust or shorten the distance between the transmitter and receiver.
- b) If there is no video being displayed and the “Format not supported” icon appears, it is an indication that the video frame rate from the computer is not supported. If this is the case, refer to page 26 to switch to a supported video timing setting.
- c) If you have more than one transmitter paired to the receiver, all devices need to be at least 6.5 feet away from one another. If the transmitter and the receiver exist in the same room, the suggested distance between the two is a minimum of 6.5 feet.

## **Powering Off and Restarting**

---

If it becomes necessary to power off the unit, before starting it back up you must do the following:

1. Safely disconnect device from the source. Then proceed to remove the transmitter from the source.
2. Shut down all devices that are connected to the VE819R.
3. Unplug the power cable and wait 10 seconds, then restart the receiver and reconnect the devices.
4. After the VE819T / VE819R is up, power on the connected devices.

This Page Intentionally Left Blank



# Chapter 4

## OSD Operation

### Overview

---

The On-Screen Display (OSD) is a menu driven method to handle VE819T / VE819R control and switching operations. The OSD appears on the attached HDMI display after the transmitter/receiver connection is established and a button on the remote control is pressed.

### OSD Main Interface

Press the **Transmitter No.** key on the remote control to show the OSD on the HDMI display connected to the receiver. Up to four transmitters can be connected to the receiver. Use the **Up** and **Down** buttons on the remote control for transmitter selection.

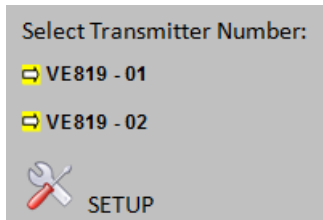

### Setup Mode

Setup is accessed from the main OSD menu and will allow you to use the following options: Add New Transmitter, Remove Transmitter and Modify Transmitter Name.

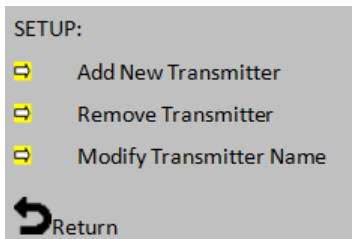

## Pairing Transmitter to Receiver

If the transmitter and receiver cannot find each other or lose their connection, follow the steps on page 16 for pairing additional transmitters to re-establish the connection.

## Switching between Wireless HDMI Transmitters

1. Press the **Transmitter No. button**. The OSD will show a list of transmitters linked to the receiver.

Use the **Up / Down** buttons to select the transmitter you want to display on your HDTV / HD projector. Then press **OK** and allow 10-12 seconds for the receiver and transmitter to re-establish a connection.

## Remove Transmitter

This section shows the OSD with the option of removing Transmitters that are paired to the receiver.

1. On the remote control, press the **Transmitter No.** button to display the list of linked transmitters.

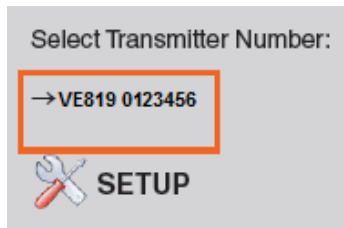

2. Select the **SETUP** menu by using the **UP / Down** buttons, then press **OK**.



3. Select the **Remove Transmitter** option.



4. Use the **Up / Down** buttons to select the transmitter to be removed and then press **OK**.

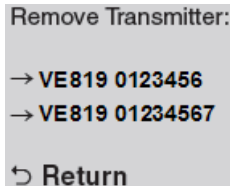

### Modify Transmitter Name

This section allows you to name your transmitters for easy use or reference. All individual paired transmitter names can be edited.

1. Use the **Up / Down** buttons to select the transmitter you want to modify.

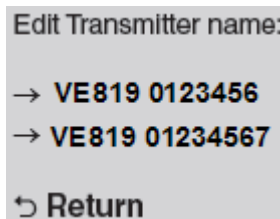

2. Then use the **Up / Down** buttons on the remote to select the alphanumeric characters; use the **Left / Right** buttons on the remote to move the cursor; Press the **Info** button to backspace.

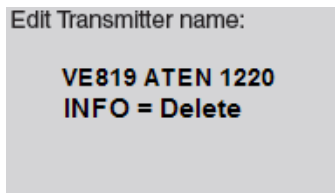

This Page Intentionally Left Blank

# Chapter 5

## Additional Transmitters

### Overview

---

Adding additional Wireless HDMI Transmitters is the perfect solution to take advantage of your large screen HDTV and send your computer's screen wirelessly or you can set your computer / game console up for wireless gaming With less than 1ms latency. The Wireless HDMI Transmitter does not require a line-of-sight placement enabling a quick, simple, and flexible wireless audio/video solution. A total of Wireless HDMI Transmitters can be added.

### Adding New Transmitters

After selecting *Add New Transmitter* the OSD will display Searching. During searching mode the transmitter's LED should be blinking.

While both the Transmitter and Receiver enter pairing mode they will search for each other automatically. When they are located the OSD will show the model name of the Transmitter that is being added to the receiver.

Once the transmitter has found the receiver it will be shown on the OSD with the option to *Select New Transmitter*.

### Pairing Mode for Transmitters

The Wireless HDMI Receiver can be paired with up to 4 Wireless HDMI Transmitters.

---

**Note:** When adding an additional transmitter, make sure the power to any transmitters already linked to the receiver is powered off before entering the receiver into pairing mode.

---

1. Once the transmitter is connected to the computer or source player and is powered on, press and hold the **Pairing Button**.
2. The transmitter is in Pairing Mode once the Power Status LED flashes slowly (1 flash/sec).

### Pairing Mode for the Receiver:

1. Once the receiver is connected to the HDTV or HD projector and is powered on, press the **Transmitter No.** button on the remote control.
2. The On-screen Display (OSD) will appear on the HDTV / HD projector. Use the **UP** or **DOWN** buttons to select the **SETUP** menu.
3. Select **Add New Transmitter** to search for an available transmitter.

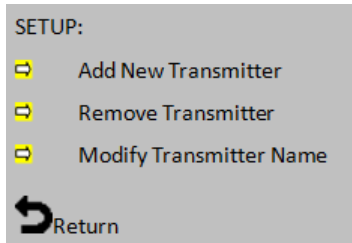

4. The OSD will display **Searching...**

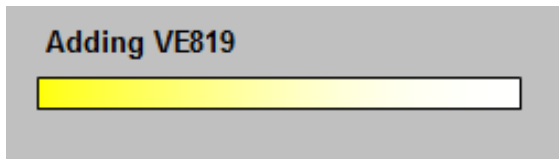
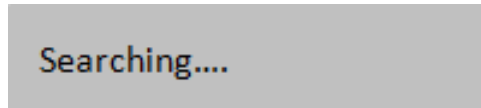

5. The Power LED on the receiver will blink PINK when it is in Pairing Mode.
6. To exit Searching Mode, press the **Transmitter No.** button on the remote control.
7. When both the transmitter and receiver are in Pairing Mode, they will search for each other and automatically pair.

After the pairing is complete, both the transmitter and receiver will reboot and establish the link to each other automatically within 5 seconds.

# Appendix

## Safety Instructions

---

- ◆ Read all of these instructions. Save them for future reference.
- ◆ Follow all warnings and instructions marked on the device.
- ◆ This product is for indoor use only.
- ◆ Do not place the device on any unstable surface (cart, stand, table, etc.). If the device falls, serious damage will result.
- ◆ Do not use the device near water.
- ◆ Do not place the device near, or over, radiators or heat registers.
- ◆ The device cabinet is provided with slots and openings to allow for adequate ventilation. To ensure reliable operation, and to protect against overheating, these openings must never be blocked or covered.
- ◆ The device should never be placed on a soft surface (bed, sofa, rug, etc.) as this will block its ventilation openings. Likewise, the device should not be placed in a built in enclosure unless adequate ventilation has been provided.
- ◆ Never spill liquid of any kind on the device.
- ◆ Unplug the device from the wall outlet before cleaning. Do not use liquid or aerosol cleaners. Use a damp cloth for cleaning.
- ◆ The device should be operated from the type of power source indicated on the marking label. If you are not sure of the type of power available, consult your dealer or local power company.
- ◆ To prevent damage to your installation, it is important that all devices are properly grounded.
- ◆ Do not allow anything to rest on the power cord or cables. Route the power cord and cables so that they cannot be stepped on or tripped over.
- ◆ Position system cables and power cables carefully; Be sure that nothing rests on any cables.
- ◆ Never push objects of any kind into or through cabinet slots. They may touch dangerous voltage points or short out parts resulting in a risk of fire or electrical shock.
- ◆ Do not attempt to service the device yourself. Refer all servicing to qualified service personnel.

- ◆ If the following conditions occur, unplug the device from the wall outlet and bring it to qualified service personnel for repair.
  - ◆ The power cord or plug has become damaged or frayed.
  - ◆ Liquid has been spilled into the device.
  - ◆ The device has been exposed to rain or water.
  - ◆ The device has been dropped, or the cabinet has been damaged.
  - ◆ The device exhibits a distinct change in performance, indicating a need for service.
  - ◆ The device does not operate normally when the operating instructions are followed.
- ◆ Only adjust those controls that are covered in the operating instructions. Improper adjustment of other controls may result in damage that will require extensive work by a qualified technician to repair.



# Specifications

Function	VE819T	VE819R
<b>Video Input</b>		
Interfaces	1 x HDMI Type-A Male (Black)	N/A
Impedance	100 $\Omega$	N/A
Max Distance	N/A	N/A
<b>Video Output</b>		
Interfaces	N/A	1 x HDMI Type-A Female (Black)
Impedance	N/A	100 $\Omega$
Max. Distance	N/A	3 m (2L-7D03H)
<b>Video</b>		
Max. Data Rate	6.75 Gbps (2.25 Gbps Per Lane)	6.75 Gbps (2.25 Gbps Per Lane)
Max. Pixel Clock	225 MHz	225 MHz
Compliance	HDMI (3D) HDCP Compatible	HDMI (3D) HDCP Compatible
Max Resolutions / Distance	Up to 1080p / 60Hz@ 10 m (Line of Sight)	Up to 1080p / 60Hz@ 10 m (Line of Sight)
<b>Audio</b>		
Input	1 x HDMI Type-A Male (Black)	N/A
Output	N/A	1 x HDMI Type-A Female (Black)
<b>Control</b>		
IR	N/A	1 x 2.5mm Mini Stereo Jack Female (Black)
<b>Power</b>		
Connectors	1 x Mini USB Jack	1 x Mini USB Jack
Consumption	DC5V: 2.5W (Mini USB)	DC5V, 7.84W (Mini USB)
<b>Environmental</b>		
Operating Temperature	0 - 40°C	0 - 40°C
Storage Temperature	-20°C - 60°C	-20°C - 60°C
Humidity	0 - 80% RH, Non Condensing	0 - 80% RH, Non Condensing

---

Function	VE819T	VE819R
<b>Physical Properties</b>		
Housing	Plastic	Plastic
Weight	0.03 kg (0.07 lb)	0.13 kg (0.29 lb)
Dimensions (L x W x H)	3.00 x 7.03 x 1.75 cm (1.18 x 2.77 x 0.69 in)	9.50 x 9.50 x 3.33 cm (3.74 x 3.74 x 1.31 in)

---

**Note:** For optimal video quality, the transmission distance shall not exceed 7 m. The true effective transmission distance may vary depending on the installation site; solid obstacles such as steel, concrete, and brick may affect transmission quality and shorten its effective distance.

---

## Supported Video and Audio Formats

2D Video Format Timings	Resolution
<b>Primary CEA Video Timing</b>	
640x480p @ 59.94 / 60Hz	480p
720x480p @ 59.94Hz	
720x480p @ 60Hz	
720x576p @ 50Hz	576p
1280x720p @ 50Hz	720p
1280x720p @ 59.94 / 60Hz	
1920x1080i @ 50Hz	1080i
1920x1080i @ 59.94 / 60Hz	
1920x1080p @ 50Hz	1080p / 60
1920x1080p @ 59.94 / 60Hz	
<b>VESA Timing (DVI Only)</b>	
640x480 @ 59.94 / 72.809Hz	VGA
800x600 @ 60.317 / 72.188Hz	SVGA
1024x768 @ 60 / 70.069Hz	XGA
1280x1024 @ 60 Hz	SXGA

<b>Mandatory CEA 3D Video Format Timings</b>
1280x720p @ 50Hz Top-and-Bottom
1280x720p @ 50Hz Frame packing
1280x720p @ 59.94 / 60Hz Top-and-Bottom
1280x720p @ 59.94 / 60Hz Frame packing
1920x1080i @ 50Hz Side-by-Side (Half)
1920x1080i @ 59.94 / 60Hz Side-by-Side (Half)
1920x1080p @ 23.98 / 24Hz Top-and-Bottom
1920x1080p @ 23.98 / 24Hz Frame packing

<b>Audio Bit Rate Support</b>				
<b>2 Channel PCM</b>	<b>Supported Sampling Rate</b>			
16 bits	32 KHz	44.1 KHz	48 KHz	96 KHz
24 bits	32 KHz	44.1 KHz	48 KHz	96 KHz

## Troubleshooting

Operation problems can be due to a variety of causes. The first step in solving them is to make sure that all cables are securely attached and seated completely in their sockets.

Problem	Resolution
The Power LED does not light up.	Check that the power adapters of the Transmitter / Receiver are properly plugged into a functioning power outlet.
No video shows on the HDMI display.	<ul style="list-style-type: none"> <li>◆ Check that the cables from the input source devices to the Transmitter are correct and properly attached.</li> <li>◆ Ensure that the display is set to receive HDMI signals.</li> <li>◆ Verify the status of <b>Power</b> LED, as follows:               <ul style="list-style-type: none"> <li>◆ <b>Power</b> LED blinking (blue):                   <ul style="list-style-type: none"> <li>– Check that the distance between the Transmitter and Receiver does not exceed 100 feet.</li> <li>– Move the Transmitter closer to the Receiver.</li> </ul> </li> <li>◆ <b>Power</b> LED lights solid + <b>Source</b> LED blinking slowly (blue)                   <ul style="list-style-type: none"> <li>– Ensure that the video resolution and frame rate selected are supported. See <i>Supported Video and Audio Formats</i>, page 25 for more details.</li> <li>– Connect the source device to your display to check the video format compatibility.</li> <li>– Check if the video resolution on your HDMI display is set to 1080p, 1080i, 720p, 576p, or 480p resolution. Refer to <i>Supported Video and Audio Formats</i>, page 25.</li> </ul> </li> <li>◆ <b>Power</b> LED lights solid + <b>Source</b> LED blinking quickly (blue)                   <ul style="list-style-type: none"> <li>– Check that the cables from the input source devices to the Transmitter are correct and properly attached.</li> <li>– Ensure your input source devices are powered on.</li> <li>– Check that proper cable is connected between the Receiver and the HDMI display device.</li> </ul> </li> </ul> </li> </ul>

Problem	Resolution
Poor picture quality or intermittent video	<ul style="list-style-type: none"> <li>◆ Check if the video resolution on your HDMI display is set to 1080p, 1080i, 720p, 576p, or 480p resolution. Refer to <i>Supported Video and Audio Formats</i>, page 25.</li> <li>◆ Check that the distance between the Transmitter and Receiver does not exceed 100 feet.</li> <li>◆ Solid structures (walls, panels, beams) between the Transmitter and Receiver can affect signal quality. Consider installing the units with the least amount of barriers between them.</li> </ul>
No audio	<ul style="list-style-type: none"> <li>◆ Check your display's volume is not set to Mute.</li> <li>◆ Check your input source device's audio volume has been enabled. Adjust the volume accordingly.</li> <li>◆ Ensure the bit rate of audio from the source device is supported (refer to page 25).</li> </ul>
IR Remote Control cannot control input source device.	<ul style="list-style-type: none"> <li>◆ Check where is IR sensor is located on the input source device. Make sure that the IR Blaster Extender Sensor is close aligned to the input source device's IR sensor.</li> <li>◆ Change the IR Blaster Extender frequency to meet the input source device's requirement.</li> </ul>
No 3D video output	<ul style="list-style-type: none"> <li>◆ Check that the connected HDMI displays on the Transmitter and Receiver can support 3D video format.</li> <li>◆ Turn off 2D HDTV mode on your HDMI display (that supports 3D video format) and reboot the display. Set the input source device to 3D video format output for the 3D display.</li> <li>◆ Check the video output setting of the input source device (ex. Blu-ray Disc, PS3..etc.) supports 3D video format.</li> <li>◆ Ensure the 3D format timing from the input source device is supported (refer to page 25).</li> </ul>

## Wall Placement Template

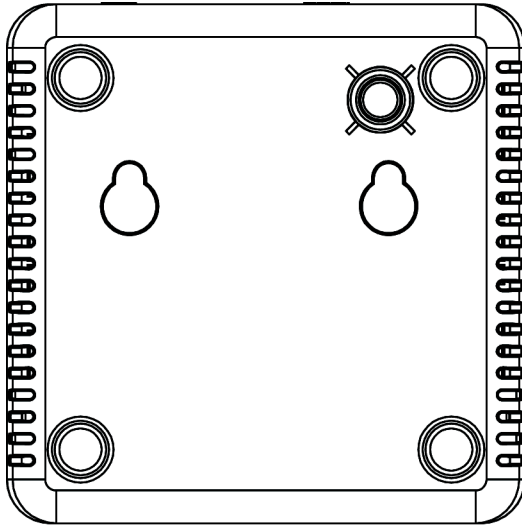

## Limited Warranty

---

ATEN warrants its hardware in the country of purchase against flaws in materials and workmanship for a Warranty Period of two [2] years (warranty period may vary in certain regions/countries) commencing on the date of original purchase. This warranty period includes the [LCD panel of ATEN LCD KVM switches](#). Select products are warranted for an additional year (see [A+ Warranty](#) for further details). Cables and accessories are not covered by the Standard Warranty.

### **What is covered by the Limited Hardware Warranty**

ATEN will provide a repair service, without charge, during the Warranty Period. If a product is defective, ATEN will, at its discretion, have the option to (1) repair said product with new or repaired components, or (2) replace the entire product with an identical product or with a similar product which fulfills the same function as the defective product. Replaced products assume the warranty of the original product for the remaining period or a period of 90 days, whichever is longer. When the products or components are replaced, the replacing articles shall become customer property and the replaced articles shall become the property of ATEN.

To learn more about our warranty policies, please visit our website:  
<http://www.aten.com/global/en/legal/policies/warranty-policy/>

© Copyright 2021 ATEN® International Co., Ltd.  
Released: 2021-06-16

ATEN and the ATEN logo are registered trademarks of ATEN International Co., Ltd. All rights reserved. All other brand names and trademarks are the registered property of their respective owners.