



**DVI Dual View KVM Extender
CE604**

User Manual



EMC Information

FEDERAL COMMUNICATIONS COMMISSION INTERFERENCE STATEMENT: This equipment has been tested and found to comply with the limits for a Class A digital device, pursuant to Part 15 of the FCC Rules. These limits are designed to provide reasonable protection against harmful interference when the equipment is operated in a commercial environment. This equipment generates, uses, and can radiate radio frequency energy and, if not installed and used in accordance with the instruction manual, may cause harmful interference to radio communications. Operation of this equipment in a residential area is likely to cause harmful interference in which case the user will be required to correct the interference at his own expense.

The device complies with Part 15 of the FCC Rules. Operation is subject to the following two conditions: (1) this device may not cause harmful interference, and (2) this device must accept any interference received, including interference that may cause undesired operation.

FCC Caution: Any changes or modifications not expressly approved by the party responsible for compliance could void the user's authority to operate this equipment.

CE Warning: This is a class A product. In a domestic environment this product may cause radio interference in which case the user may be required to take adequate measures.

Suggestion: Shielded twisted pair (STP) cables must be used with the unit to ensure compliance with FCC & CE standards.

KCC Statement

유선 제품용 / A 급 기기 (업무용 방송 통신 기기)
이 기기는 업무용 (A 급) 전자파적합기기로서 판매자 또는 사용자는 이
점을 주의하시기 바라며, 가정 외의 지역에서 사용하는 것을 목적으로
합니다.

RoHS

This product is RoHS compliant.



User Information

Online Registration

Be sure to register your product at our online support center:

International	http://eservice.aten.com
---------------	-----------------------------------------------------------------

Telephone Support

For telephone support, call this number:

International	886-2-8692-6959
China	86-400-810-0-810
Japan	81-3-5615-5811
Korea	82-2-467-6789
North America	1-888-999-ATEN ext 4988 1-949-428-1111

User Notice

- ◆ All information, documentation, and specifications contained in this manual are subject to change without prior notification by the manufacturer. The manufacturer makes no representations or warranties, either expressed or implied, with respect to the contents hereof and specifically disclaims any warranties as to merchantability or fitness for any particular purpose. Any of the manufacturer's software described in this manual is sold or licensed *as is*. Should the programs prove defective following their purchase, the buyer (and not the manufacturer, its distributor, or its dealer), assumes the entire cost of all necessary servicing, repair and any incidental or consequential damages resulting from any defect in the software.

The manufacturer of this system is not responsible for any radio and/or TV interference caused by unauthorized modifications to this device. It is the responsibility of the user to correct such interference.

The manufacturer is not responsible for any damage incurred in the operation of this system if the correct operational voltage setting was not selected prior to operation. PLEASE VERIFY THAT THE VOLTAGE SETTING IS CORRECT BEFORE USE.

- ◆ This ATEN product is specifically designed and manufactured for the operation and management of computer mainframe and communications equipment used in network management centers. As such, it may not be completely appropriate for those environments and sites where special standards for performance and high reliability are required – such as military equipment, traffic management, nuclear facilities, security systems, communications equipment, medical facilities, etc.

Package Contents

The CE604 package consists of:

- ◆ 1 CE604L (Local Unit)
- ◆ 1 CE604R (Remote Unit)
- ◆ 1 USB DVI KVM Cable Set
- ◆ 1 DVI Cable
- ◆ 2 Power Adapters
- ◆ 1 Mounting Kit
- ◆ 1 User Instructions*

Check to make sure that all the components are present and that nothing got damaged in shipping. If you encounter a problem, contact your dealer.

Read this manual thoroughly and follow the installation and operation procedures carefully to prevent any damage to the unit, and/or any of the devices connected to it.

* Features may have been added to the CE604 since this manual was published. Please visit our website to download the most up-to-date version of the manual.

© Copyright 2015 ATEN® International Co., Ltd.
Manual Date: 2019-11-20

ATEN and the ATEN logo are registered trademarks of ATEN International Co., Ltd. All rights reserved.
All other brand names and trademarks are the registered property of their respective owners.

Contents

EMC Information	ii
RoHS	ii
User Information	iii
Online Registration	iii
Telephone Support	iii
User Notice	iii
Package Contents	iv
About this Manual	vii
Conventions	viii
Product Information	viii
Chapter 1.	
Introduction	
Overview	1
Features	2
Requirements	3
Consoles	3
Computers	3
Cables	3
Operating Systems	4
Components	5
CE604L (Local Unit) Front View	5
CE604R (Remote Unit) Front View	6
CE604L (Local Unit) Rear View	7
CE604R (Remote Unit) Rear View	8
Chapter 2.	
Hardware Setup	
Rack Mounting	9
Installation	10
Grounding	10
Setting Up	12
Installation Diagrams	13
Chapter 3.	
Operation	
Picture Adjustment	15
LED Display	15
CE604L (Local Units)	15
CE604R (Remote Unit)	16
Hotkey Setting Mode	16
Invoking HSM	16
When Hotkey Mode is active:	17
Alternate HSM Invocation Keys	17
Hotkey Summary Table	18

Chapter 4.

The Firmware Upgrade Utility

Upgrade Methods	19
Local Unit Mode	20
Remote Unit Mode	23
Local and Remote Mode	25
Upgrade Succeeded	27
Upgrade Failed	28

Appendix

Safety Instructions	29
General	29
Rack Mounting	31
Technical Support	32
International	32
North America	32
Specifications	33
Troubleshooting	34
Limited Warranty	35

About this Manual

This User Manual is provided to help you get the most from your system. It covers all aspects of installation, configuration and operation. An overview of the information found in the manual is provided below.

Chapter 1, Introduction, introduces you to the CE604 system. Its purpose, features and benefits are presented, and its front and back panel components are described.

Chapter 2, Hardware Setup, describes the steps that are necessary to quickly and safely set up your installation.

Chapter 3, Operation, explains the fundamental concepts involved in operating the CE604

Chapter 4, The Firmware Upgrade Utility, explains how to use this utility to upgrade the CE604's firmware with the latest available versions.

An Appendix, provides specifications and other technical information regarding the CE604.

Conventions

This manual uses the following conventions:

- `Monospaced` Indicates text that you should key in.
- [] Indicates keys you should press. For example, [Enter] means to press the **Enter** key. If keys need to be chorded, they appear together in the same bracket with a plus sign between them: [Ctrl+Alt].
1. Numbered lists represent procedures with sequential steps.
- ◆ Bullet lists provide information, but do not involve sequential steps.
- Indicates selecting the option (on a menu or dialog box, for example), that comes next. For example, Start → Run means to open the *Start* menu, and then select *Run*.
-  Indicates critical information.

Product Information

For information about all ATEN products and how they can help you connect without limits, visit ATEN on the Web or contact an ATEN Authorized Reseller. Visit ATEN on the Web for a list of locations and telephone numbers:

International	http://www.aten.com
North America	http://www.aten-usa.com

Chapter 1

Introduction

Overview

The CE604 is a DVI Dual View USB based KVM Extender that features Dual View functionality, which enables the video output to seamlessly display on two monitors. With RS-232 serial functionality, it allows access to a computer system from a remote console up to 60 m away. The CE604 is built for control and security purposes, and is targeted towards financial and industrial markets.

The CE604 is equipped with an RS-232 serial channel that connects to a serial terminal or to serial devices, such as touch screens and barcode scanners. In addition, it supports an advanced PC Wake Up feature, which allows you to simply press a pushbutton from the remote dual view console to wake a PC at the local site. The CE604 eliminates the need for traveling back and forth between the local computer and remote console, making it an efficient and flexible solution.

The CE604 is ideal for applications that require the console to be in a conveniently accessible location, while the system equipment needs to reside in a safe place – away from dust, dirt and harsh environmental influences. It also provides a cost-effective way of keeping sensitive data, such as financial and personal information, safe in a heavily secured data center, while still allowing remote access to users.

Features

- ◆ Local and Remote Units connect at distances up to 60 m using two Cat 5e cables
- ◆ Transmit speaker, keyboard, mouse, DDC and one DVI via one Cat5 cable; RS-232, microphone and another DVI by adding a second Cat 5e cable
- ◆ Allows access to a computer or KVM installation from a remote console (up to 60m)
- ◆ Supports Dual View video source transmission (one PC with two video output ports)
- ◆ Audio Enabled – supports stereo speakers and microphone
- ◆ Supports Real DDC bypass and ATEN default EDID technology – set up various configurations via hotkeys
- ◆ RS-232 serial channel – connect to a serial terminal, or serial devices such as touchscreens and barcode scanners (Baud Rate up to 9600 bps)
- ◆ Compatible with other ATEN Dual View KVM devices, such as CS1642A/CS1644A and CS1762A/CS1764A
- ◆ Superior video quality – up to 1920 x 1200 @ 60 Hz at 30 m; 1024 x 768 @ 60 Hz at 60 m
- ◆ Supports PC wakeup function via one pushbutton or hotkey
- ◆ Manual compensation control to adjust video signal quality in order to compensate for distance
- ◆ Supports Wide Screen formats
- ◆ Built-in 8KV/15KV ESD protection (Contact voltage 8KV; Air voltage 15KV) and 2KV surge protection
- ◆ Firmware upgradeable
- ◆ Rack mountable

Requirements

Consoles

- ◆ Up to 2 DVI monitors
- ◆ A USB keyboard
- ◆ A USB mouse
- ◆ Stereo microphone and stereo speakers (optional)

Computers

The following equipment must be installed on each computer that is to be connected to the system:

- ◆ 2 DVI ports
- ◆ USB port for the mouse and keyboard
- ◆ Microphone and speaker ports (optional)

Cables

- ◆ For optimal signal integrity, and to simplify the layout, we strongly recommend that you use ATEN's high quality custom KVM Cable that is provided with this package.
- ◆ Cat 5e cable is required to connect the Local and Remote CE604 Units. Cable of a lower standard will result in degrading of the video signal. We strongly recommend using Cat 5e cables. For better quality over longer distances, we suggest using 2L-2801 (350 MHz) Low Skew Cable

Maximum Cable Distances

Connection	Distance
Computer to Local Unit (CE604L)	5 m
Local Unit (CE604L) to Remote Unit (CE604R)	60 m at 1024 x 768 @ 60 Hz 30 m at 1920 x 1200 @ 60 Hz
Remote Unit (CE604R) to monitor	5 m

Operating Systems

Supported operating systems are shown in the table, below:

- ◆ Windows
- ◆ Linux
- ◆ Sun
- ◆ Mac

Components

CE604L (Local Unit) Front View

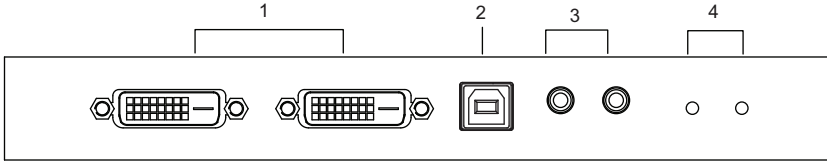

No.	Component	Description
1	DVI ports	Using the USB DVI KVM cable set / DVI cable provided with this package, connect your computer to the appropriate ports.
2	USB Type B Input	The USB cable from your computer or USB hub plugs in here. Note: The provided USB DVI KVM cable set includes this USB cable.
3	Audio Ports	These mini stereo ports are for the speakers (green) and microphone (pink).
4	LEDs	The CE604L has two LEDs to indicate the operating status. See page 15 for full details.

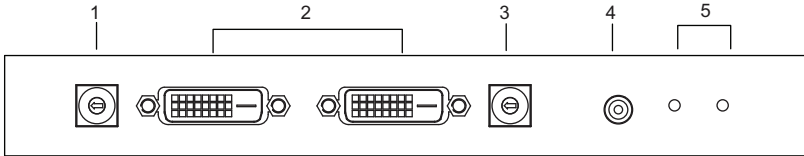
CE604R (Remote Unit) Front View

No.	Component	Description
1	EQ Switch 1	Use this to adjust the video quality of the remote console connected to DVI port 1.
2	DVI ports	Connect your compatible monitor(s) to these ports.
3	EQ Switch 2	Use this to adjust the video quality of the remote console connected to DVI port 2.
4	Wake Up button	Press this if you are at the remote console's location and you want to wake a computer on the local site. Press this to upgrade the CE604R firmware. See page 23 for details.
5	LEDs	The CE604R has two LEDs to indicate operating status. See page 16 for full details.

CE604L (Local Unit) Rear View

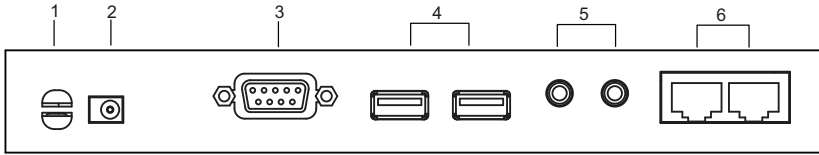

No.	Component	Description
1	Cable clip	Use this to clip the power adapter cable in place.
2	Power Jack	The cable from the power adapter connects here.
3	F/W Upgrade Switch	Use this switch to turn on the firmware upgrade mode. Reset the power to proceed with the firmware upgrade. Switch it off and reset the power to return to normal mode.
4	RS-232 Serial Port	Connect the RS-232 cable from your computer into this port.
5	Sub / Main	The Cat 5e cable that connects the Remote and Local Units plugs in here. (Note: If another DVI signal and RS-232 / microphone signals are needed, the Sub cable must be connected.)

CE604R (Remote Unit) Rear View

No.	Component	Description
1	Cable clip	Use this to clip the power adapter cable in place.
2	Power Jack	The cable from the power adapter connects here.
3	RS-232 Serial Port	RS-232 serial devices – such as touchscreens or barcode scanners – plug into this port.
4	USB	The USB cable for your keyboard / mouse plugs in here.
5	Audio Ports	These mini stereo ports are for the speakers (green) and microphone (pink).
6	Sub / Main	The Cat 5e cable that connects the Remote and Local Units plugs in here. (Note: If another DVI signal and RS-232 / microphone signals are needed, the Sub cable must be connected.)

Chapter 2

Hardware Setup



1. Important safety information regarding the placement of this device is provided on page 29. Please review it before proceeding.
2. Make sure that the power to all devices connected to the installation are turned off. You must unplug the power cords of any computers that have the Keyboard Power On function.

Rack Mounting

For convenience and flexibility, the CE604 can be mounted on system racks. To rack mount a unit do the following:

1. Using the screws provided in the Mounting Kit, screw the mounting bracket into the top or bottom of the unit.
2. Screw the bracket into any convenient location on the rack.

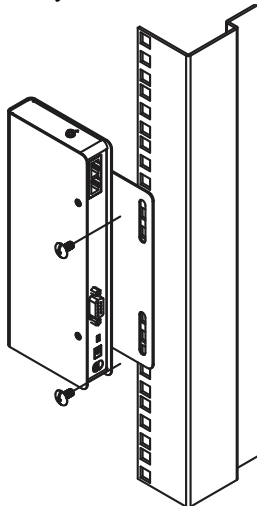

Note: These screws are not provided. We recommend that you use M5 x 12 Phillips Type I cross, recessed type screws.

Installation

Grounding

To prevent damage to your installation it is important that all devices are properly grounded.

1. Use the two grounding wires supplied with this package to ground both units by connecting one end of the wire to the grounding terminal, and the other end of the wire to a suitable grounded object.

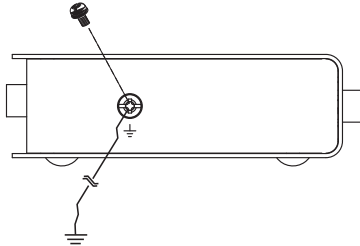

2. Make sure that the computer that the Local Unit connects to and the monitor that the Remote Unit connects to are properly grounded.

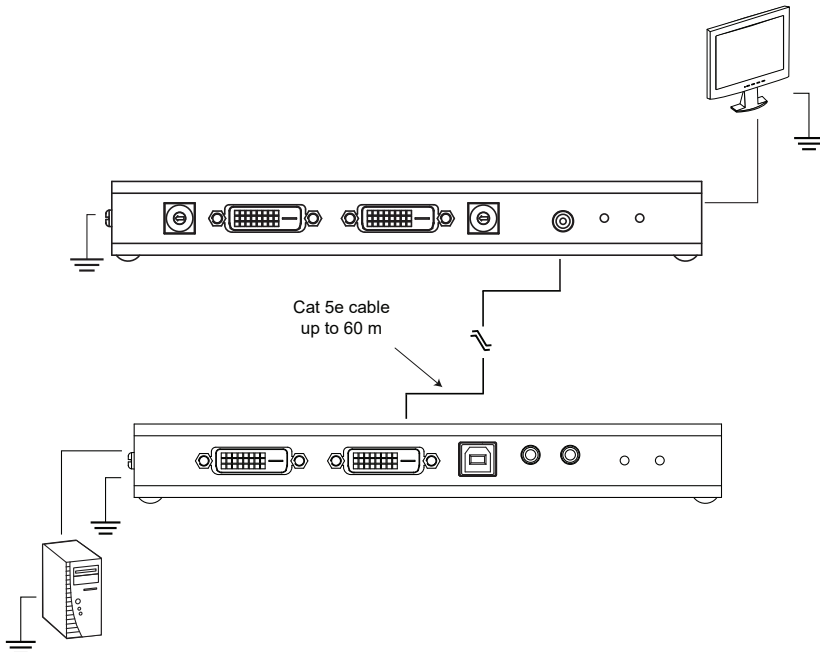

3. For increased grounding protection, use STP (shielded twisted pair) cable to connect the Local and Remote Units. There are two methods that can be used:

- a) In addition to the eight paired wires, STP cable also contains a grounding wire. Solder this wire to the RJ-45 connector as shown in the diagram below:

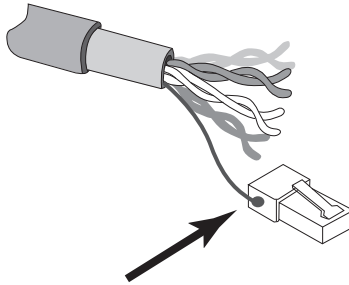

- b) The second method is to use the STP cable shielding for grounding. In this case, make sure that the shielding makes tight contact with the top inside of the RJ-45 connector as shown in the diagram below:

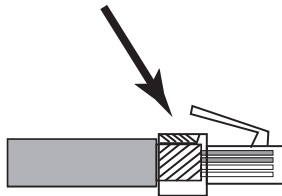

In either case, make sure that the sides of the RJ-45 connector make tight contact with the grounding contacts on the sides of the RJ-45 socket as shown in the diagram below:

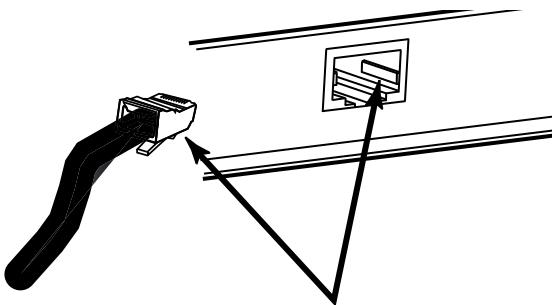

Setting Up

Setting up the CE604 DVI KVM Extender system is simply a matter of plugging in the cables. Make sure that all the equipment to be connected up is powered Off. Refer to the installation diagram on the following page and do the following:

1. Plug the connectors on the USB DVI KVM cable set / DVI cable supplied with this unit into the appropriate ports on the front of the Local Unit (CE604L).
2. Plug the connectors on the other end of the DVI KVM cable / DVI cable into the appropriate ports on the local computer.

Note: If you are combining the CE604 with a KVM switch, the other end of the DVI KVM cable plugs into the appropriate ports on the KVM switch.

3. Plug a compatible monitor/display into the CE604R front panel DVI port. Do the same on a second monitor/display.
4. (Optional) For control of serial devices, connect the RS-232 serial port on the remote unit to a serial device or the serial port of a local computer.
5. Plug either end of the Cat 5e cable into the CE604L's Sub / Main ports. Plug the other end of the Cat 5e cable into the Sub / Main ports of the Remote Unit (CE604R).
6. Plug one of the power adapters (supplied with this package) into a DC source; plug the adapter's power cable into the CE604L's Power Jack.
7. Plug the cables from the remote console devices (mouse, keyboard, monitor, speakers, microphone), into their ports on the Console side of the CE604R.
8. Plug the second power adapter (supplied with this package) into a DC source; plug the adapter's power cable into the CE604R's Power Jack.

Installation Diagrams

Front View

CE604L (Front)

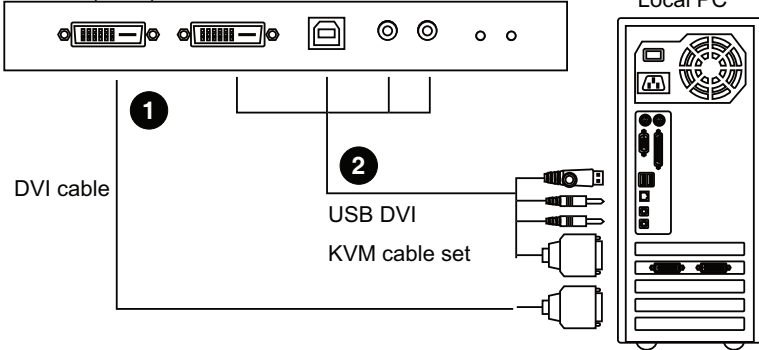

CE604R (Front)

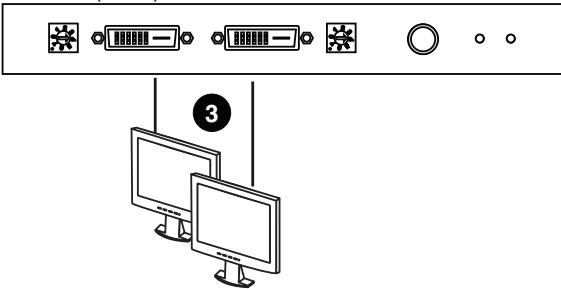

Rear View

CE604L (Rear)

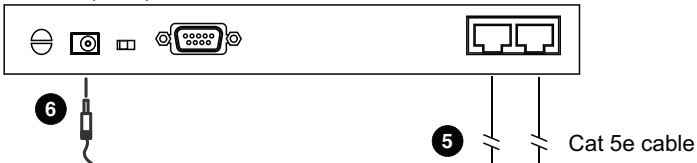

CE604R (Rear)

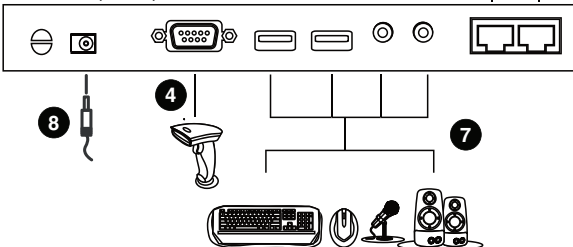

This Page Intentionally Left Blank

Chapter 3

Operation

Picture Adjustment

Use the EQ switch to adjust the equalization strength and improve an image. There is an EQ switch that corresponds to each display connected to the CE604R (front panel).

The values range from 0-7 where:

- ♦ 7: strongest equalization
- ♦ 0: weakest equalization

LED Display

The CE604 Local and Remote Units have front panel LEDs to indicate their operating status, as shown in the tables, following:

CE604L (Local Units)

LED	Indication
Link (Green)	<ul style="list-style-type: none">♦ Lights steadily to indicate that the connection to the Remote unit is ok.♦ Flashes every 0.25 seconds to indicate that there is a problem on the Cat5 Main connection.♦ Flashes every 0.5 seconds to indicate that there is a problem on the Cat5 Sub connection.♦ Flashes together with the Power LED to indicate that firmware upgrade is in progress.
Power (Green)	<ul style="list-style-type: none">♦ Lights steadily to indicate that the Local unit is receiving power.♦ Flashes together with the Link LED to indicate that firmware upgrade is in progress.

CE604R (Remote Unit)

LED	Indication
Link (Green)	<ul style="list-style-type: none">◆ Lights steadily to indicate that the connection to the Local Unit is ok.◆ Flashes every 0.25 seconds to indicate that there is a problem on the Cat5 Main connection.◆ Flashes every 0.5 seconds to indicate that there is a problem on the Cat5 Sub connection.◆ Flashes together with the Power LED to indicate that firmware upgrade is in progress.
Power (Green)	<ul style="list-style-type: none">◆ Lights steadily to indicate that the Remote unit is receiving power.◆ Flashes together with the Link LED to indicate that firmware upgrade is in progress.

Hotkey Setting Mode

The administrator and users can use hotkey combinations to configure a number of the DVI KVM Extender's working environment parameters. All Hotkey operations begin by invoking Hotkey Setting Mode (HSM).

Invoking HSM

To invoke HSM, do the following:

1. Hold down **[Ctrl]**.
2. Press and release **[F12]**.
3. Release **[Ctrl]**.

Note: There is an alternative key combination to invoke HSM (see *Alternate HSM Invocation Keys*, page 17).

When Hotkey Mode is active:

- ◆ The Caps Lock, and Scroll Lock LEDs flash in succession to indicate that HSM is in effect. They stop flashing and revert to normal status when you exit HSM.
- ◆ Ordinary keyboard and mouse functions are suspended – only Hotkey compliant keystrokes and mouse clicks (described in the sections that follow), can be input.
- ◆ At the conclusion of some hotkey operations, you automatically exit hotkey mode. With some operations, you must exit manually. To exit HSM manually, press **[Esc]** or **[Spacebar]**.

Alternate HSM Invocation Keys

An alternate set of HSM invocation keys is provided in case the default set conflicts with programs running on the computers.

To switch to the alternate HSM invocation set, do the following:

1. Invoke HSM (see page 16).
2. Press and release **[h]**.

The HSM invocation keys become the Num Lock key (instead of Ctrl) and the minus key (instead of F12).

Note: This procedure is a toggle between the two methods. To revert back to the original [Ctrl] [F12] method, invoke HSM, then press and release the **h** key again.

Hotkey Summary Table

After invoking HSM (see page 16), key in one of the following keys to perform the corresponding function:

Key	Function
[h]	Toggles between the default ([Ctrl] [F12]) and alternate ([Num Lock] [-]) Hotkey invocation keys.
[k]	Wakes a computer on the local site.
[F1]	Sets the PC compatible keyboard operating platform for the port that currently has the KVM focus.
[F2]	Sets the Mac compatible keyboard operating platform for the port that currently has the KVM focus.
[F3]	Sets the Sun keyboard operating platform for the port that currently has the KVM focus.
[F6]	Uses ATEN default EDID mode.
[F7]	Uses Extender EDID mode.
[r]	Reset settings to the default values, as follows: <ul style="list-style-type: none">◆ Invoking HSM: [Ctrl] + [F12]◆ OS Setting: PC Compatible OS◆ Extender EDID Mode
[Esc] or [Spacebar]	Exit HSM.

Note: The brackets indicate the keys you should press. Simply press the indicated keys – do not type the brackets.

Chapter 4

The Firmware Upgrade Utility

The Windows-based Firmware Upgrade Utility (using the file name CE604X_ATEN_Vx.x.xxx.exe) provides a smooth, automated process for upgrading the KVM switch's firmware.

The Utility comes as part of a Firmware Upgrade Package that is specific for each device. New firmware upgrade packages are posted on our web site as new firmware revisions become available. Check the web site regularly to find the latest packages and information relating to them:

<http://www.aten.com>

Upgrade Methods

There are three ways to upgrade the CE604 firmware, as follows:

- ◆ Upgrade the CE604L (Local Unit Mode) individually
- ◆ Upgrade the CE604R (Remote Unit Mode) individually
- ◆ Upgrade the CE604L and CE604R (Local and Remote Mode) together

These Firmware Upgrade modes are described in the proceeding sections.

Before You Begin

Using a computer connected to the CE604L / CE604R, go to our Internet support site and choose the model name of your device (CE604) to get a list of available Firmware Upgrade Packages.

Choose the Firmware Upgrade Package you want to install (usually the most recent), and download it to your computer.

Local Unit Mode

To prepare for the Firmware Upgrade, do the following:

1. Turn off the CE604L and unplug the power adapter.
2. In the Local Unit's rear panel, turn the FW Upgrade switch **On**. This enables the Local Unit to operate in Firmware Upgrade Mode when it is powered on again.
3. Plug in the power adapter and power on the CE604L. Note that the LEDs start flashing.
4. Use a serial RS-232 straight cable (Male to Female) to connect a COM port on your computer to the CE604L's RS-232 port.

Note: The serial RS-232 straight cable (Male to Female) is not provided in the package. If you would like to purchase a serial RS-232 straight cable (Male to Female), please visit a local electronic component store.

Starting the Upgrade

To upgrade your firmware:

1. Run the downloaded Firmware Upgrade Package file (CE604L_ATEN_Vx.x.xxx.exe) – either by double clicking the file icon, or by opening a command line and entering the full path to it.

The Firmware Upgrade Utility Welcome screen appears:

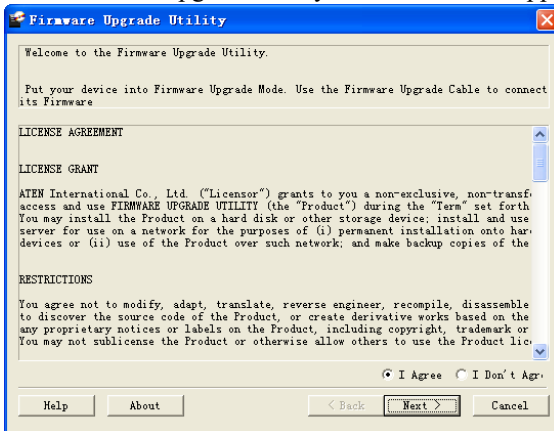

Note: The screens shown in this section are for reference only. The wording and layout of the actual screens put up by the Firmware Upgrade Utility may vary slightly from these examples.

2. Read and agree to the **License Agreement** (enable the **I Agree** radio button).
3. Click **Next** to continue. The Firmware Upgrade Utility main screen appears:

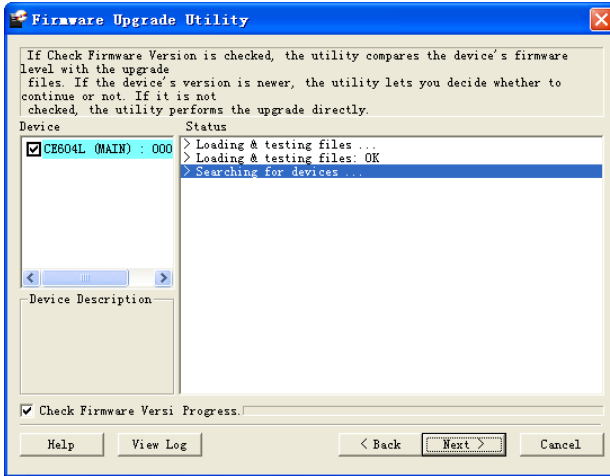

The Utility inspects your installation. The Local Unit is listed in the **Device List** panel and automatically selected for upgrade.

4. Click **Next** to perform the upgrade.

If you enabled **Check Firmware Version**, the Utility compares the device's firmware level with that of the upgrade files. If it finds that the device's version is higher than the upgrade version, it brings up a dialog box informing you of the situation and gives you the option to **Continue** or **Cancel**.

If you did not enable **Check Firmware Version**, the Utility installs the upgrade files without checking whether or not they are a higher level.

As the upgrade proceeds, status messages appear in the **Status Messages** panel, and the progress toward completion is shown on the **Progress...** bar. The highlight / color of the device name in the **Device List** panel also changes as follows:

- ♦ Green - the device is being prepared for upgrade
- ♦ Blue - firmware upgrade is in progress
- ♦ Magenta - firmware upgrade is successful

Upgrade Succeeded

After the upgrade has completed, a screen appears to inform you that the procedure was successful:

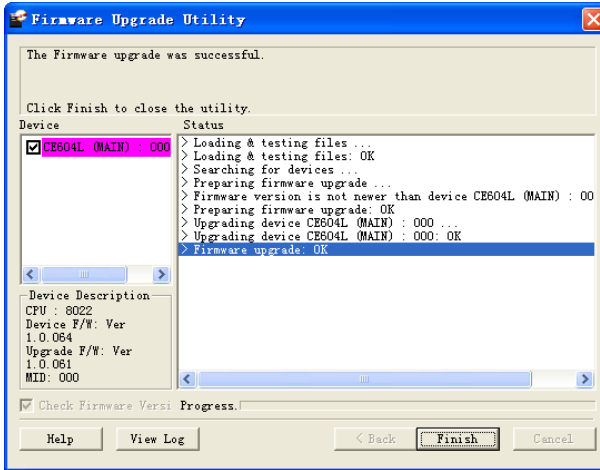

1. Click **Finish** to close the Firmware Upgrade Utility.
2. After successfully upgrading the firmware, unplug the Local Unit's power adapter.
3. Turn the FW Upgrade switch **Off** to exit the Firmware Upgrade Mode for the CE604L.
4. Plug in the Local Unit's power adapter to turn it on.

Remote Unit Mode

To prepare for the Firmware Upgrade, do the following:

1. Turn off the CE604R and unplug the power adapter.
2. In the Remote Unit's front panel, press the **Wake Up** button at the same time, plug in the power adapter and power on the CE604R. Note that the LEDs are flashing.
3. Use a serial RS-232 cross cable (Female to Female) to connect a COM port on your computer to the CE604L's RS-232 port.

Note: The Serial RS-232 cross cable (Female to Female) is not provided in the package. If you would like to purchase a serial RS-232 cross cable (Female to Female), please visit a local electronic component store.

Starting the Upgrade

To upgrade your firmware:

1. Run the downloaded Firmware Upgrade Package file (CE604R_ATEN_Vx.x.xxx.exe) – either by double clicking the file icon, or by opening a command line and entering the full path to it.

The Firmware Upgrade Utility Welcome screen appears.

2. Read and agree to the **License Agreement** (enable the **I Agree** radio button).
3. Click **Next** to continue. The Firmware Upgrade Utility main screen appears:

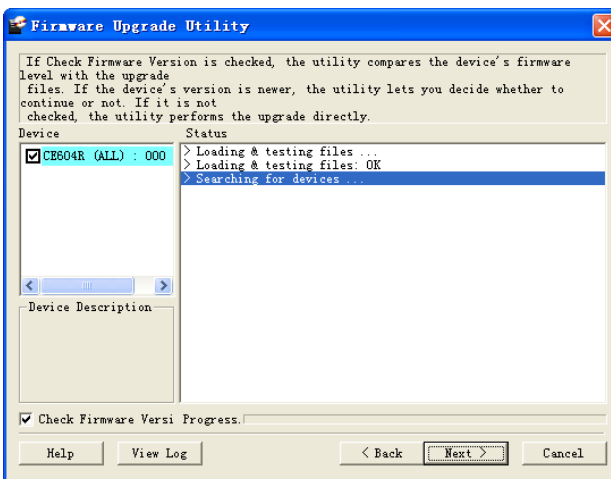

The Utility inspects your installation. The Remote Unit is listed in the **Device List** panel and automatically selected for upgrade.

4. Click **Next** to perform the upgrade.

If you enabled **Check Firmware Version**, the Utility compares the device's firmware level with that of the upgrade files. If it finds that the device's version is higher than the upgrade version, it brings up a dialog box informing you of the situation and gives you the option to **Continue** or **Cancel**.

If you did not enable **Check Firmware Version**, the Utility installs the upgrade files without checking whether or not they are a higher level.

As the upgrade proceeds, status messages appear in the **Status Messages** panel, and the progress toward completion is shown on the **Progress...** bar. The highlight / color of the device name in the **Device List** panel also changes as follows:

- ♦ Green - the device is being prepared for upgrade
- ♦ Blue - firmware upgrade is in progress
- ♦ Magenta - firmware upgrade is successful

Upgrade Succeeded

After the upgrade has completed, a screen appears to inform you that the procedure was successful:

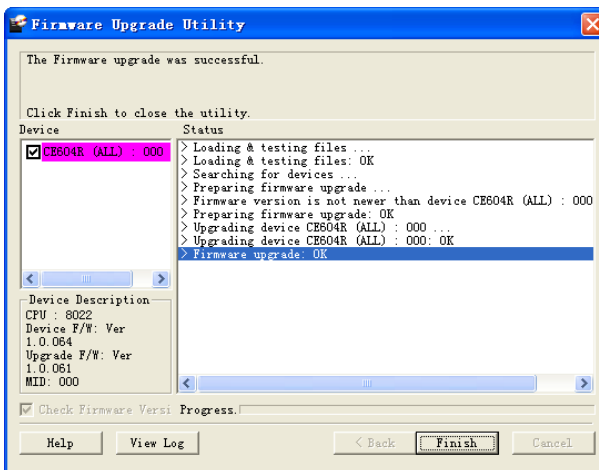

1. Click **Finish** to close the Firmware Upgrade Utility.

2. After successfully upgrading the firmware, unplug the Remote Unit's power adapter.
3. Plug in the Remote Unit's power adapter to turn it on.

Local and Remote Mode

To prepare for the Firmware Upgrade, do the following:

1. Turn off both CE604L and CE604R units and unplug their power adapters.
2. Make sure both units are connected using two Cat 5e cables.
3. In the Local Unit's rear panel, turn the FW Upgrade switch **On**.

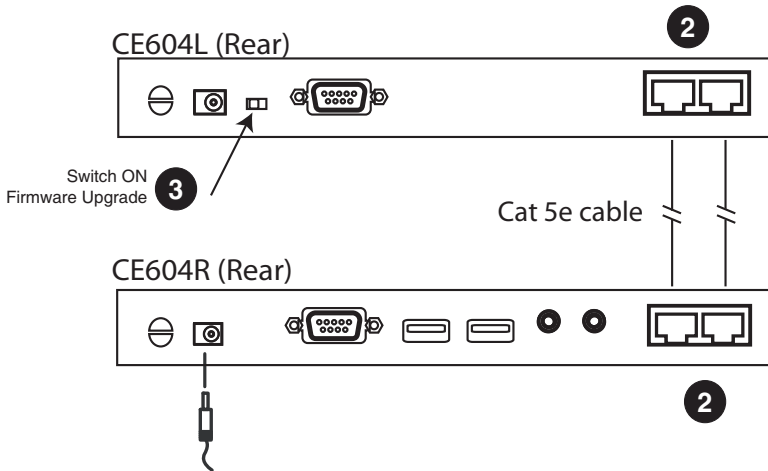

4. Plug in the power adapter and power on the CE604R.
5. Plug in the power adapter and power on the CE604L. Note that the LEDs on both Local and Remote units start flashing.
6. Use a Serial RS-232 cable to connect a COM port on your computer to the CE604L's RS-232 port.

Note: The Serial RS-232 cable is not provided in the package.

Starting the Upgrade

To upgrade your firmware:

1. Run the downloaded Firmware Upgrade Package file (CE604L_ATEN_Vx.x.xxx.exe) – either by double clicking the file icon, or by opening a command line and entering the full path to it.

The Firmware Upgrade Utility Welcome screen appears.

2. Read and agree to the **License Agreement** (enable the **I Agree** radio button).
3. Click **Next** to continue. The Firmware Upgrade Utility main screen appears.

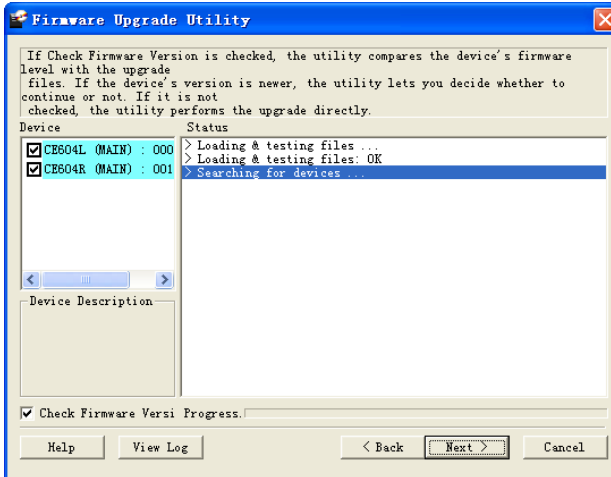

The Utility inspects your installation. The Local and Remote Units are listed in the **Device List** panel and automatically selected for upgrade.

Note: You can select either the Local or Remote Unit if you want to upgrade the devices individually, or select both devices to upgrade them together.

4. Click **Next** to perform the upgrade.

If you enabled **Check Firmware Version**, the Utility compares the device's firmware level with that of the upgrade files. If it finds that the device's version is higher than the upgrade version, it brings up a dialog box informing you of the situation and gives you the option to **Continue** or **Cancel**.

If you did not enable **Check Firmware Version**, the Utility installs the upgrade files without checking whether or not they are a higher level.

As the upgrade proceeds, status messages appear in the **Status Messages** panel, and the progress toward completion is shown on the **Progress...** bar. The highlight / color of the device name in the **Device List** panel also changes as follows:

- ◆ Green - the device is being prepared for upgrade
- ◆ Blue - firmware upgrade is in progress
- ◆ Magenta - firmware upgrade is successful

Upgrade Succeeded

After the upgrade has completed, a screen appears to inform you that the procedure was successful:

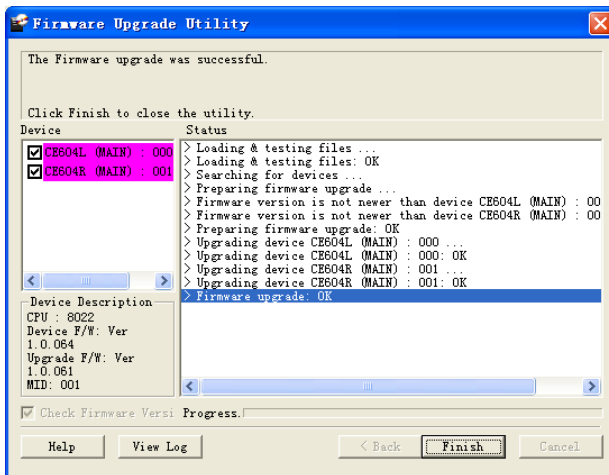

1. Click **Finish** to close the Firmware Upgrade Utility.
2. After successfully upgrading the firmware, unplug the Local unit's power adapter.
3. Turn the FW Upgrade switch **Off** on the Local Unit to exit the Firmware Upgrade Mode.
4. Unplug both the Local and Remote Units.
5. Plug in the Local Unit / Remote Unit power adapter to turn it on.

Upgrade Failed

For Local Unit and Remote Unit upgrade modes, if the *Upgrade Succeeded* screen does not appear, then the upgrade failed to complete successfully. You should repeat the upgrade procedure from the beginning.

For the Local and Remote Unit upgrade mode (upgrading both units at the same time):

- ◆ If the CE604L upgrade failed, switch to Local Unit Mode and try to upgrade the unit individually.
- ◆ If the CE604R upgrade failed, switch to Remote Unit Mode and try to upgrade the unit individually.

Safety Instructions

General

- ◆ Read all of these instructions. Save them for future reference.
- ◆ Follow all warnings and instructions marked on the device.
- ◆ This product is for indoor use only.
- ◆ Do not place the device on any unstable surface (cart, stand, table, etc.). If the device falls, serious damage will result.
- ◆ Do not use the device near water.
- ◆ Do not place the device near, or over, radiators or heat registers.
- ◆ The device cabinet is provided with slots and openings to allow for adequate ventilation. To ensure reliable operation, and to protect against overheating, these openings must never be blocked or covered.
- ◆ The device should never be placed on a soft surface (bed, sofa, rug, etc.) as this will block its ventilation openings. Likewise, the device should not be placed in a built in enclosure unless adequate ventilation has been provided.
- ◆ Never spill liquid of any kind on the device.
- ◆ Unplug the device from the wall outlet before cleaning. Do not use liquid or aerosol cleaners. Use a damp cloth for cleaning.
- ◆ The device should be operated from the type of power source indicated on the marking label. If you are not sure of the type of power available, consult your dealer or local power company.
- ◆ The device is designed for IT power distribution systems with 230V phase-to-phase voltage.
- ◆ To prevent damage to your installation, it is important that all devices are properly grounded.
- ◆ The device is equipped with a 3-wire grounding type plug. This is a safety feature. If you are unable to insert the plug into the outlet, contact your electrician to replace your obsolete outlet. Do not attempt to defeat the purpose of the grounding-type plug. Always follow your local/national wiring codes.
- ◆ Do not allow anything to rest on the power cord or cables. Route the power cord and cables so that they cannot be stepped on or tripped over.

- ◆ If an extension cord is used with this device make sure that the total of the ampere ratings of all products used on this cord does not exceed the extension cord ampere rating. Make sure that the total of all products plugged into the wall outlet does not exceed 15 amperes.
- ◆ To help protect your system from sudden, transient increases and decreases in electrical power, use a surge suppressor, line conditioner, or un-interruptible power supply (UPS).
- ◆ Position system cables and power cables carefully; Be sure that nothing rests on any cables.
- ◆ Never push objects of any kind into or through cabinet slots. They may touch dangerous voltage points or short out parts resulting in a risk of fire or electrical shock.
- ◆ Do not attempt to service the device yourself. Refer all servicing to qualified service personnel.
- ◆ If the following conditions occur, unplug the device from the wall outlet and bring it to qualified service personnel for repair.
 - ◆ The power cord or plug has become damaged or frayed.
 - ◆ Liquid has been spilled into the device.
 - ◆ The device has been exposed to rain or water.
 - ◆ The device has been dropped, or the cabinet has been damaged.
 - ◆ The device exhibits a distinct change in performance, indicating a need for service.
 - ◆ The device does not operate normally when the operating instructions are followed.
- ◆ Only adjust those controls that are covered in the operating instructions. Improper adjustment of other controls may result in damage that will require extensive work by a qualified technician to repair.

Rack Mounting

- ◆ Before working on the rack, make sure that the stabilizers are secured to the rack, extended to the floor, and that the full weight of the rack rests on the floor. Install front and side stabilizers on a single rack or front stabilizers for joined multiple racks before working on the rack.
- ◆ Always load the rack from the bottom up, and load the heaviest item in the rack first.
- ◆ Make sure that the rack is level and stable before extending a device from the rack.
- ◆ Use caution when pressing the device rail release latches and sliding a device into or out of a rack; the slide rails can pinch your fingers.
- ◆ After a device is inserted into the rack, carefully extend the rail into a locking position, and then slide the device into the rack.
- ◆ Do not overload the AC supply branch circuit that provides power to the rack. The total rack load should not exceed 80 percent of the branch circuit rating.
- ◆ Make sure that all equipment used on the rack – including power strips and other electrical connectors – is properly grounded.
- ◆ Ensure that proper airflow is provided to devices in the rack.
- ◆ Ensure that the operating ambient temperature of the rack environment does not exceed the maximum ambient temperature specified for the equipment by the manufacturer.
- ◆ Do not step on or stand on any device when servicing other devices in a rack.

Technical Support

International

- ◆ For online technical support – including troubleshooting, documentation, and software updates: **<http://eservice.aten.com>**
- ◆ For telephone support, see *Telephone Support*, page iii.

North America

Email Support		support@aten-usa.com
Online Technical Support	Troubleshooting Documentation Software Updates	http://www.aten-usa.com/support
Telephone Support		1-888-999-ATEN ext 4988

When you contact us, please have the following information ready beforehand:

- ◆ Product model number, serial number, and date of purchase.
- ◆ Your computer configuration, including operating system, revision level, expansion cards, and software.
- ◆ Any error messages displayed at the time the error occurred.
- ◆ The sequence of operations that led up to the error.
- ◆ Any other information you feel may be of help.

Specifications

Function		CE604L	CE604R	
Connectors	KVM Ports	USB	1 x USB Type B Female (White)	N/A
		Speakers	1 x Mini Stereo Jack Female (Green)	N/A
		Mic.	1 x Mini Stereo Jack Female (Pink)	N/A
		Video input	1 x DVI-D Female (White)	N/A
	Console Ports	Video	N/A	2 x DVI-D Female (White)
		Speakers	N/A	1 x Mini Stereo Jack Female (Green)
		Mic.	N/A	1 x Mini Stereo Jack Female (Pink)
		Keyboard	N/A	1 x USB Type A Female (White)
		Mouse	N/A	1 x USB Type A Female (White)
	RS-232	1 x DB-9 Female (Black)	1 x DB-9 Male (Black)	
	Power	1 x DC Jack (Black)		
	Sub / Main	2 x RJ-45 Female (Black)		
	LEDs	Link	1 (Green)	1 (Green)
Power		1 (Green)	1 (Green)	
Switches	Compensation switch	N/A	2 x 8-position switch	
	F/W Upgrade	1 x Slide Switch	N/A	
Buttons	Wake Up button	N/A	1 pushbutton	
Video		1920 x 1200 @ 60Hz (30 m); 1024 x 768 @ 60Hz (60 m)		
Power Consumption		DC5.3V, 3.4W	D5.3V, 4.3W	
Environment	Operating Temp.	0–50°C		
	Storage Temp	-20–60°C		
	Humidity	0–80% RH, Non-condensing		
Physical Properties	Housing	Metal		
	Weight	0.48 kg		
	Dimensions (L x W x H)	20.20 x 8.54 x 2.50 cm	20.20 x 8.70 x 2.50 cm	

Troubleshooting

Operation problems can be due to a variety of causes. The first step in solving them is to make sure that all cables are securely attached and seated completely in their sockets.

Problem	Action
No video	Make sure that all cables are securely plugged into their sockets.
Poor quality video	The video quality can be improved by adjusting the EQ switch on the CE604R to increase or reduce the video signal compensation.
	The video quality can be improved by reducing the refresh rate.

Limited Warranty

ATEN warrants its hardware in the country of purchase against flaws in materials and workmanship for a Warranty Period of two [2] years (warranty period may vary in certain regions/countries) commencing on the date of original purchase. This warranty period includes the LCD panel of ATEN LCD KVM switches. Select products are warranted for an additional year (see *A+ Warranty* for further details). Cables and accessories are not covered by the Standard Warranty.

What is covered by the Limited Hardware Warranty

ATEN will provide a repair service, without charge, during the Warranty Period. If a product is defective, ATEN will, at its discretion, have the option to (1) repair said product with new or repaired components, or (2) replace the entire product with an identical product or with a similar product which fulfills the same function as the defective product. Replaced products assume the warranty of the original product for the remaining period or a period of 90 days, whichever is longer. When the products or components are replaced, the replacing articles shall become customer property and the replaced articles shall become the property of ATEN.

To learn more about our warranty policies, please visit our website:

<http://www.aten.com/global/en/legal/policies/warranty-policy/>