



# PE5-8108 / PE5-8208

8-Outlet 1U Metered eco PDU  
User Manual

## Compliance Statements

---

### FEDERAL COMMUNICATIONS COMMISSION INTERFERENCE STATEMENT

This equipment has been tested and found to comply with the limits for a Class A digital device, pursuant to Part 15 of the FCC Rules. These limits are designed to provide reasonable protection against harmful interference when the equipment is operated in a commercial environment. This equipment generates, uses, and can radiate radio frequency energy and, if not installed and used in accordance with the instruction manual, may cause harmful interference to radio communications. Operation of this equipment in a residential area is likely to cause harmful interference in which case the user will be required to correct the interference at his own expense.

The device complies with Part 15 of the FCC Rules. Operation is subject to the following two conditions: (1) this device may not cause harmful interference, and (2) this device must accept any interference received, including interference that may cause undesired operation.

### FCC Caution

Any changes or modifications not expressly approved by the party responsible for compliance could void the user's authority to operate this equipment.

### Warning

Operation of this equipment in a residential environment could cause radio interference.

### Achtung

Der Gebrauch dieses Geräts in Wohnumgebung kann Funkstörungen verursachen.



---

**Note:** The UL Listed compatible models are:

PE5108A, PE5108B, PE5208A, PE5208B, PE6108A, PE6108B,  
PE6208A, PE6208B, PE7108A, PE7108B, PE7208A, PE7208B,  
PE8108A, PE8108B, PE8208A, and PE8208B.

---

**KCC Statement**

유선 제품용 / A 급 기기 (업무용 방송 통신 기기)  
이 기기는 업무용 (A 급) 전자파적합기기로서 판매자 또는 사용자는 이  
점을 주의하시기 바라며, 가정 외의 지역에서 사용하는 것을 목적으로  
합니다.

**Industry Canada Statement**

This Class A digital apparatus complies with Canadian ICES-003.

**CAN ICES-003 (A) / NMB-003 (A)**

**VCCI Statement**

この装置は、クラスA機器です。この装置を住宅環境で使用すると電波妨害  
を引き起こすことがあります。この場合には使用者が適切な対策を講ずるよう  
要求されることがあります。

**VCCI - A**

**RoHS**

This product is RoHS compliant.

## PE Device Safety Notice



- ◆ Set the maximum permissible breaker protection in the building circuitry to the current rating specified on the rating plate. Observe all national regulations and safety codes as well as deviations for breakers.
- ◆ Only connect the PE Device to a grounded power outlet or a grounded system!
- ◆ Make sure that the total current input of the connected systems does not exceed the current rating specified on the rating plate of the PE Device.
- ◆ There is a risk of explosion if the battery is replaced with an incorrect type. Dispose of used batteries according to the relevant instructions.

## Consignes de sécurité relatives à l'unité PE



- ◆ Installez sur le circuit du bâtiment des disjoncteurs permettant d'assurer la protection maximale autorisée, en respectant le courant nominal spécifié sur la plaque signalétique. Veuillez respecter l'ensemble des réglementations nationales en vigueur et des codes de sécurité ainsi que les déviations recommandées pour les disjoncteurs.
- ◆ Ne connectez l'unité PE qu'à une prise de courant avec borne de terre ou à un système mis à la terre!
- ◆ Assurez-vous que le courant d'entrée total des systèmes connectés ne dépasspas le courant nominal spécifié sur la plaque signalétique de l'unité PE.
- ◆ Il existe un risque d'explosion si la batterie est remplacée par une batterie de type incorrect. Jetez les batteries usagées en respectant les instructions adéquates.

## User Information

---

### Online Registration

Be sure to register your product at our online support center:

International	<a href="http://eservice.aten.com">http://eservice.aten.com</a>
---------------	---

### Telephone Support

For telephone support, call this number:

International	886-2-8692-6959
China	86-400-810-0-810
Japan	81-3-5615-5811
Korea	82-2-467-6789
North America	1-888-999-ATEN ext 4988 1-949-428-1111

### User Notice

All information, documentation, and specifications contained in this manual are subject to change without prior notification by the manufacturer. The manufacturer makes no representations or warranties, either expressed or implied, with respect to the contents hereof and specifically disclaims any warranties as to merchantability or fitness for any particular purpose. Any of the manufacturer's software described in this manual is sold or licensed *as is*. Should the programs prove defective following their purchase, the buyer (and not the manufacturer, its distributor, or its dealer), assumes the entire cost of all necessary servicing, repair and any incidental or consequential damages resulting from any defect in the software.

The manufacturer of this system is not responsible for any radio and/or TV interference caused by unauthorized modifications to this device. It is the responsibility of the user to correct such interference.

The manufacturer is not responsible for any damage incurred in the operation of this system if the correct operational voltage setting was not selected prior to operation. PLEASE VERIFY THAT THE VOLTAGE SETTING IS CORRECT BEFORE USE.

## Product Information

---

For information about all ATEN products and how they can help you connect without limits, visit ATEN on the Web or contact an ATEN Authorized Reseller. Visit ATEN on the Web for a list of locations and telephone numbers:

International	<a href="http://www.aten.com">http://www.aten.com</a>
North America	<a href="http://www.aten-usa.com">http://www.aten-usa.com</a>

## Package Contents

---

Check to make sure that all the components are in working order. If you encounter any problem, please contact your dealer.

The eco PDU standard package consists of:

- ◆ 1 PE5108 / PE5208 / PE6108 / PE6208 / PE7108 / PE7208 / PE8108 / PE8208 Power Distribution Unit
- ◆ 1 power cord
- ◆ 1 mounting kit
- ◆ 1 user instructions\*

---

\* Features may have been added to the eco PDU since this manual was released. Please visit our website to download the most up-to-date version.

---

# Contents

---

Compliance Statements . . . . .	ii
Consignes de sécurité relatives à l'unité PE . . . . .	iv
User Information . . . . .	v
Online Registration . . . . .	v
Telephone Support . . . . .	v
User Notice . . . . .	v
Product Information . . . . .	vi
Package Contents . . . . .	vi
Contents . . . . .	vii
About This Manual . . . . .	x
Conventions . . . . .	xi

## Chapter 1. Introduction

Overview . . . . .	1
PE Series eco PDU Comparison Chart . . . . .	3
Features . . . . .	4
Power Distribution . . . . .	4
Remote Access . . . . .	4
Operation . . . . .	4
Management . . . . .	5
Security . . . . .	5
Requirements . . . . .	6
Optional Accessories . . . . .	7
Sensors . . . . .	7
Cable Holders . . . . .	7
Components . . . . .	8
PE5108A / PE7108A Front View . . . . .	8
PE5208A / PE7208A Front View . . . . .	8
PE5108A / PE5208A / PE7108A / PE7208A Rear View . . . . .	8
PE5108A / PE5208A / PE7108A / PE7208A Readout Section . . . . .	9
PE5108B / PE5108G / PE7108B / PE7108G Front View . . . . .	11
PE5208B / PE5208G / PE7208B / PE7208G Front View . . . . .	11
PE5108B / PE5108G / PE5208B / PE5208G / PE7108B / PE7108G / PE7208B / PE7208G Rear View . . . . .	11
PE5108B / PE5108G / PE5208B / PE5208G / PE7108B / PE7108G / PE7208B / PE7208G Readout Section . . . . .	12
PE6108A / PE8108A Front View . . . . .	14
PE6208A / PE8208A Front View . . . . .	14
PE6108A / PE6208A / PE8108A / PE8208A Rear View . . . . .	14
PE6108A / PE6208A / PE8108A / PE8208A Readout Section . . . . .	15
PE6108B / PE6108G / PE8108B / PE8108G Front View . . . . .	17
PE6208B / PE6208G / PE8208B / PE8208G Front View . . . . .	17
PE6108B / PE6108G / PE6208B / PE6208G / PE8108B / PE8108G / PE8208B / PE8208G Rear View . . . . .	17

PE6108B / PE6108G / PE6208B / PE6208G / PE8108B / PE8108G /  
PE8208B / PE8208G Readout Section ..... 18

**Chapter 2. Hardware Setup**

Before You Begin ..... 21  
Rack Mounting ..... 21  
Installation ..... 22  
    Securing the Cables ..... 23  
    Securing the Sensors ..... 24

**Chapter 3. Basic Operation and  
First Time Setup**

Operation Methods ..... 25  
    Browser ..... 25  
    eco DC ..... 26  
    SNMP ..... 26  
First Time Setup ..... 27  
    Network Configuration ..... 28  
    Changing the Administrator Login ..... 29  
Moving On ..... 29

**Chapter 4. Browser Operation**

Logging In ..... 31  
The eco PDU Main Page ..... 32  
    Page Components ..... 33  
Energy ..... 34  
    Connections ..... 34  
    Configuration ..... 37  
User ..... 40  
    Administrator Information ..... 40  
    User Information ..... 41  
Log ..... 42  
    The System Log Event List ..... 42  
    Notification Settings ..... 43  
Setup ..... 44  
    Device Configuration ..... 44  
    Date/Time ..... 50  
    Security ..... 52  
    Login Failures ..... 52  
    Working Mode ..... 52  
    Account Policy ..... 53  
    Login String / IP Filter / Mac Filter ..... 54  
    Authentication & Authorization ..... 57  
    Private Certificate ..... 58  
PDU ..... 60  
    Firmware File ..... 60  
    Backup/Restore ..... 62



---

Safety Instructions	63
General	63
Consignes de sécurité	66
Général	66
Rack Mounting	69
The eco PDU's Main Power Cord	69
Securing the Power Cables	69
Montage sur bâti	70
Le cordon d'alimentation principale de l'unité d'alimentation éco	70
Fixation des câbles d'alimentation	70
Technical Support	72
International	72
North America	72
IP Address Determination	73
Specifications	75
PE5108A / PE5208A / PE7108A / PE7208A	75
PE5108B / PE5208B / PE7108B / PE7208B	76
PE5108G / PE5208G / PE7108G / PE7208G	77
PE6108A / PE6208A / PE8108A / PE8208A	78
PE6108B / PE6208B / PE8108B / PE8208B	79
PE6108G / PE6208G / PE8108G / PE8208G	80
Administrator Login Failure	81
Limited Warranty	82

## About This Manual

---

This user manual is provided to help you get the most out of your eco PDU. It covers all aspects of the power distribution unit, including installation, configuration, and operation.

The eco PDU models covered in this manual include:

Model	
PE5108	15A/10A 8-Outlet 1U Metered eco PDU
PE5208	20A/16A 8-Outlet 1U Metered eco PDU
PE6108	15A/10A 8-Outlet 1U Metered & Switched eco PDU
PE6208	20A/16A 8-Outlet 1U Metered & Switched eco PDU
PE7108	15A/10A 8-Outlet 1U Outlet-Metered eco PDU
PE7208	20A/16A 8-Outlet 1U Outlet-Metered eco PDU
PE8108	15A/10A 8-Outlet 1U Outlet-Metered & Switched eco PDU
PE8208	20A/16A 8-Outlet 1U Outlet-Metered & Switched eco PDU

An overview of the information found in the manual is provided below.

**Chapter 1, Introduction**, introduces the eco PDU, its purpose, features, and benefits, with its front and back panel components described.

**Chapter 2, Hardware Setup**, provides step-by-step instructions for setting up the eco PDU.

**Chapter 3, Basic Operation and First-time Setup**, explains the basic operations of the eco PDU, and the necessary configurations for first-time setup.

**Chapter 4, Browser Operation**, explains how to log into the eco PDU remotely from a web browser, and the various functions it provides.

**Appendix**, provides specifications and other technical information regarding the eco PDU.

---

### Note:

- ♦ Read this manual thoroughly and follow the installation and operation procedures carefully to prevent any damage to the unit and/or connected devices.

- ◆ The product may be updated, with features and functions added, improved, or removed since the release of this manual. For an up-to-date user manual, visit <http://www.aten.com/global/en/>.
- 

## **Conventions**

This manual uses the following conventions:

- |   |  |
|---|--|
| Monospaced  | Indicates text that you should key in.   |
| [ ]   | Indicates keys you should press. For example, [Enter] means to press the <b>Enter</b> key. If keys need to be chorded, they appear together in the same bracket with a plus sign between them: [Ctrl+Alt]. |
| 1.  | Numbered lists represent procedures with sequential steps.   |
| ◆   | Bullet lists provide information, but do not involve sequential steps.   |
| >   | Indicates selecting consecutive options (such as on a menu or dialog box). For example, Start > Run means to open the <i>Start</i> menu, and then select <i>Run</i> .                                      |
|  | Indicates critical information.  |

This Page Intentionally Left Blank

# Chapter 1

## Introduction

### Overview

---

ATEN PE5108 / PE5208/ PE6108 / PE6208 / PE7108 / PE7208 /PE8108 / PE8208 eco PDUs are intelligent PDUs that contain 8 AC outlets for convenient and efficient data power usage management, and are available in various IEC or NEMA socket configurations.

They provide secure, centralized, intelligent power management (power on, off, cycle) for data center IT equipment (servers, storage systems, KVM switches, network devices, serial data devices, etc.), as well as the ability to monitor the center's environment conditions via sensors\*. The basic characteristics of each model are shown in the table on page 3.

ATEN eco PDUs offer remote power control combined with real-time power measurement, allowing users to control and monitor the power status of all devices powered by the PDUs, either at the PDU device or outlet level, from practically any location via a TCP/IP connection.

The power status of each outlet can be set individually, allowing users to switch each device on/off. The eco PDU also offers comprehensive power analysis reports that can be separated by departments and/or locations, providing precise measurements of the current, voltage, power, and watt-hour in real time.

Installation and operation is fast and easy: as simple as plugging cables into their appropriate ports and configuring on a user-friendly web browser for intuitive management. Since the eco PDU firmware is upgradeable over a network, users can keep the PDUs updated with the latest functionality improvements by downloading updates from their product pages, as they become available.

ATEN eco PDU supports any 3rd-party SNMP v3 manager software and ATEN eco DC (eco PDU manager web GUI). ATEN eco DC provides you with an easy method for managing multiple devices, offering an intuitive and user-friendly graphical user interface that allows you to configure a PDU device and monitor power status of the equipment connected.

This series of ATEN eco PDUs have a circuit breaker alert that can sound an alarm and send SNMP trap or e-mail alerts when a trip occurs. This feature

provides a faster response time to recover servers and other devices during power loss due to circuit overload.

With its advanced security features and ease of operation, the eco PDU is the most convenient, reliable, and cost-effective way to remotely manage power access for multiple computer installations and allocate power resources efficiently.

---

**Note:** Sensors are optional accessories. A sensor-enabled installation is required to generate a more complete energy-efficient data and chart. Higher sensor installation density is helpful to generate more accurate data. See *Optional Accessories*, page 7, for further information.

---

## PE Series eco PDU Comparison Chart

Model	Power Cord (IEC C19 to)	Outlets	Monitoring Level	Amps	
				Per Port	Total
PE5108A	NEMA 5-15P	NEMA 5-15R	PDU	12A	12A
PE5108B	NEMA 6-15P	IEC C13	PDU	12A	12A
PE5108G	IEC C14	IEC C13	PDU	10A	10A
PE5208A	NEMA 5-20P	NEMA 5-20R	PDU	16A	16A
PE5208B	NEMA 6-20P	IEC C13 / C19	PDU	12A / 16A	12A
PE5208G	IEC C20	IEC C13 / C19	PDU	10A / 16A	16A
PE6108A	NEMA 5-15P	NEMA 5-15R	PDU	12A	12A
PE6108B	NEMA 6-15P	IEC C13	PDU	12A	12A
PE6108G	IEC C14	IEC C13	PDU	10A	10A
PE6208A	NEMA 5-20P	NEMA 5-20R	PDU	16A	16A
PE6208B	NEMA 6-20P	IEC C13 / C19	PDU	12A / 16A	16A
PE6208G	IEC C20	IEC C13 / C19	PDU	10A / 16A	16A
PE7108A	NEMA 5-15P	NEMA 5-15R	Outlet	12A	12A
PE7108B	NEMA 6-15P	IEC C13	Outlet	12A	12A
PE7108G	IEC C14	IEC C13	Outlet	10A	10A
PE7208A	NEMA 5-20P	NEMA 5-20R	Outlet	16A	16A
PE7208B	NEMA 6-20P	IEC C13 / C19	Outlet	12A / 16A	16A
PE7208G	IEC C20	IEC C13 / C19	Outlet	10A / 16A	16A
PE8108A	NEMA 5-15P	NEMA 5-15R	Outlet	12A	12A
PE8108B	NEMA 6-15P	IEC C13	Outlet	12A	12A
PE8108G	IEC C14	IEC C13	Outlet	10A	10A
PE8208A	NEMA 5-20P	NEMA 5-20R	Outlet	16A	16A
PE8208B	NEMA 6-20P	IEC C13 / C19	Outlet	12A / 16A	16A
PE8208G	IEC C20	IEC C13 / C19	Outlet	10A / 16A	16A

**Note:** For the complete specifications of individual models, please refer to *Specifications*, page 75.

## **Features**

---

### **Power Distribution**

- ◆ Space saving 1U rack mount design with rear mounting
- ◆ IEC or NEMA outlet models
- ◆ 3 digit 7-segment front panel LED display showing the current, IP address of PDU, and outlets
- ◆ Remote users can monitor outlet status via web browsers
- ◆ Safe shutdown support
- ◆ Separate power for the unit's own power and power outlets. The user interface is kept accessible even when an overload trips the devices' circuit breaker

### **Remote Access**

- ◆ Remote power control via TCP/IP and a built-in 10/100 Ethernet port
- ◆ Network interfaces: TCP/IP, UDP, HTTP, HTTPS, SSL, SMTP, DHCP, NTP, DNS, 10 Base-T / 100 Base-TX, auto sense, Ping
- ◆ eco PDU Power Management web GUI—eco DC
- ◆ SNMP v3 Manager support
- ◆ Telnet support

### **Operation**

- ◆ Remote power outlet control (On, Off, Power Cycle) by individual outlets
- ◆ Power-on sequencing—users can set the power on sequence and delay time for each port to allow equipment to be turned on in the proper order
- ◆ Easy setup and operation via a browser-based user interface
- ◆ Multiple browsers support (IE, Firefox, Chrome, Safari, Opera, Netscape)
- ◆ RTC support to keep the timer running during times of no power.
- ◆ Up to 8 user accounts and 1 administrator account.
- ◆ Proactive Overload Protection (POP)—automatically powers off outlets in the user-defined sequence when a current overload occurs in protecting the powered devices



## **Management**

- ◆ Power status measurement at the PDU/outlet level
- ◆ LED indicators for current and IP address at the PDU device and / or outlet levels.
- ◆ Real-time current, voltage, and kWh displayed in a browsed-based UI for monitoring at the PDU level (PE5108 / PE5208 / PE6108 / PE6208) and at the outlet level (PE7108 / PE7208 / PE8108 / PE8208)
- ◆ Circuit breaker alert sounds an alarm and sends SNMP trap or e-mail alerts when a circuit breaker trips
- ◆ Current and voltage threshold setting
- ◆ Outlet naming support
- ◆ User outlet access assignment on an outlet-by-outlet basis.
- ◆ Event logging and Syslog server support
- ◆ Upgradable firmware
- ◆ Multiple languages support: English, Traditional Chinese, Simplified Chinese, Japanese, German, Italian, Spanish, and French.

## **Security**

- ◆ Two-level password security
- ◆ Strong security features include password strength protection and advanced encryption technologies—TLS 1.2
- ◆ Remote authentication support—RADIUS

## Requirements

---

- ◆ Browsers accessing the eco PDU unit must support TLS 1.2.
- ◆ For cold booting of attached computers, the computer's BIOS must support *Wake on LAN* or *System after AC Back*.
- ◆ For safe shutdown:
  - ◆ The computer must be running Windows (Windows 2000 or above) or Linux.
  - ◆ The *Safe Shutdown* program—PMonitor—must be installed and running on the computer (available by download from our website).

---

### Note:

Safe shutdown program PMonitor can be downloaded from the *Support and Download* section of the product web page, as shown below:

Software & Drivers ▾

OS	Description	Ver.	Release Date	File Name
<i>Other</i>				
	MIB File	v1.1.115	2015-05-05	<a href="#">PE_MIB_File_v1.1.115.zip</a>
	PE MIB File	v1.1.112	2014-06-19	<a href="#">PE8_MIB_File_v1.1.112.tar</a>
	PE MIB File	v1.1.109	2013-09-06	<a href="#">PE8_MIB_File_v1.1.109.tar</a>
	IP Installer	v1.4.132	2012-02-10	<a href="#">IPInstaller-ALTUSEN_v1.4.132.zip</a>
Linux	PMonitor	v1.1	2012-02-10	<a href="#">PowerMonitor_v1.1.zip</a>
Windows	PMonitor	v1.0.081	2012-02-10	<a href="#">PMonitorSrv_v1.0.081.zip</a>
	PE MIB File	v1.0.063	2012-02-10	<a href="#">PE8_MIB_File_v1.0.063.zip</a>

## Optional Accessories

### Sensors

Sensors are optional accessories. You can use the eco PDU unit without sensors. However, if you want to have complete energy management of an instrumented data center with the use of the eco PDU, you would need to use eco DC, a management web GUI, and install 4 sensors for each of the racks to generate a complete energy-efficient data and chart. 8-port models have 2 sensor ports. In this case, sensor 1 needs to be installed at the intake of the rack and sensor 2 needs to be placed at the exhaust of IT equipment of the rack. A sensor-enabled installation is required to generate a more complete energy-efficient data and chart. Higher sensor installation density is helpful to generate more accurate data. Available sensors are shown in the table, below:

Sensor	Part Number
Temperature	EA1140
Temperature / Humidity	EA1240
Differential Pressure / Temperature	EA1340

### Sensor Management

Sensors can be managed via the eco PDU's built-in graphical user interface (GUI) or with ATEN eco DC that can be downloaded from the ATEN website.

### Cable Holders

Cable holders are optional accessories. For added safety, use ATEN Lok-U-Plug cable holders to secure the connecting cables of your attached devices in place on the eco PDU. Use only the ATEN Lok-U-Plug cable holders that have been specifically designed to work with eco PDU. Using any other types of cable securing device could be highly dangerous.

Part Number	Description
2X-EA07	Lok-U-Plug Cable Holder (10 pcs)
2X-EA08	Lok-U-Plug Installation Tool (4 pcs)

## Components

---

### PE5108A / PE7108A Front View

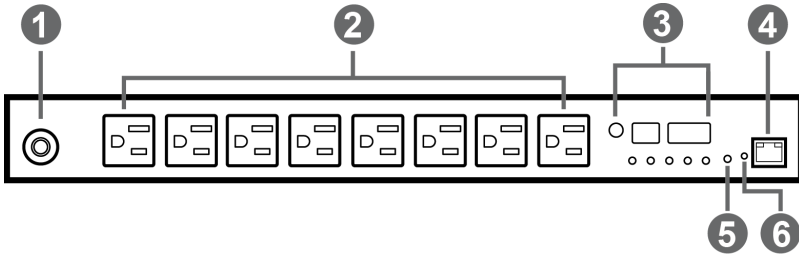

### PE5208A / PE7208A Front View

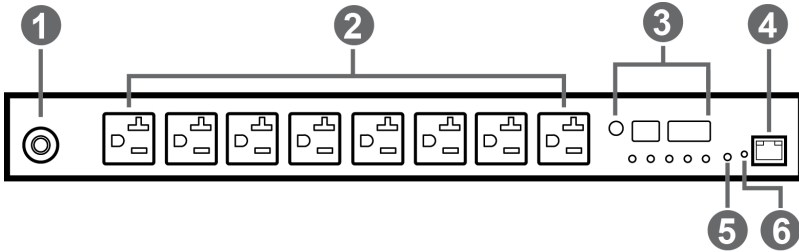

### PE5108A / PE5208A / PE7108A / PE7208A Rear View

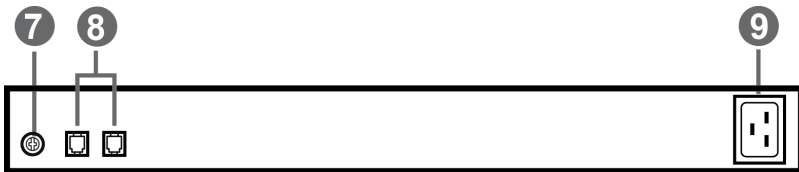

## PE5108A / PE5208A / PE7108A / PE7208A Readout Section

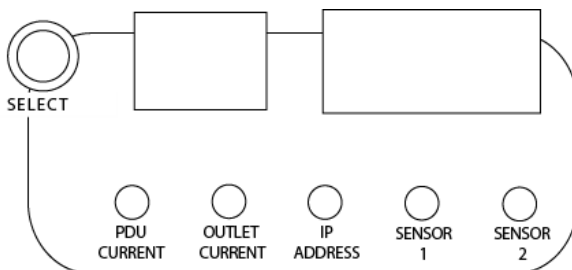

No.	Item	Description
1	circuit breaker pushbutton	As a safety measure, if there is a current overload in regards to the device's power, the circuit breakers will trip. Press the button to recover normal operation.
2	power sockets	8 x NEMA 5-15R or 8 x NEMA 5-20R <b>Note:</b> Holes for ATEN Lok-U-Plug cable holders are located around the sockets. See <i>Securing the Cables</i> , page 23, for further information.
3	readout section	<ul style="list-style-type: none"> <li>◆ The selection (PDU Current / Outlet Current / IP Address) appears in the first (1-digit) display window.</li> <li>◆ PDU Current / Outlet Current / IP Address appear in the second (3-digit) display window</li> <li>◆ The LEDs above the items indicate which one the readout relates to.</li> <li>◆ Press the button next to the first display window to cycle the selection among the items.</li> </ul>
4	LAN port and LEDs	The cable that connects the eco PDU to the LAN plugs in here. The Link and LAN LEDs are built into the LAN port: <b>Link:</b> Lights GREEN to indicate that a connection via the eco PDU's RJ-45 Ethernet port has been established. Flashes to indicate data is being transmitted. <b>LAN:</b> Lights ORANGE to indicate 10 Mbps data transmission speed. The LED lights GREEN to indicate 100 Mbps data transmission speed.
5	reset button	This button is recessed and must be pushed with a thin object, such as the end of a paper clip. <ul style="list-style-type: none"> <li>◆ Press and release to reboot the device.</li> <li>◆ Press and hold for more than three seconds to reset the eco PDU to its factory default settings</li> </ul>
6	power LED	The LED lights when the eco PDU is ready to operate.

<b>No.</b>	<b>Item</b>	<b>Description</b>
7	grounding terminal	The wire used to ground the unit connects here.
8	sensor ports	External sensors plug into these two RJ-11 ports.
9	power socket	The power cord that connects the unit to an AC power source plugs in here.

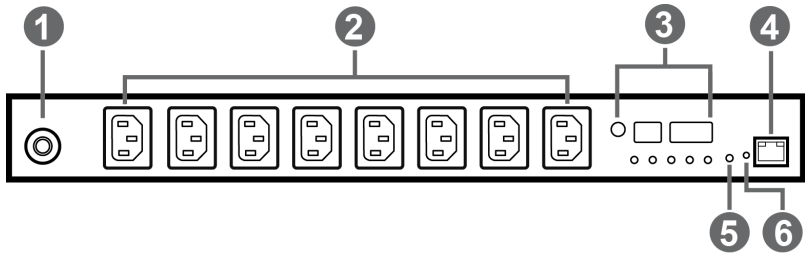
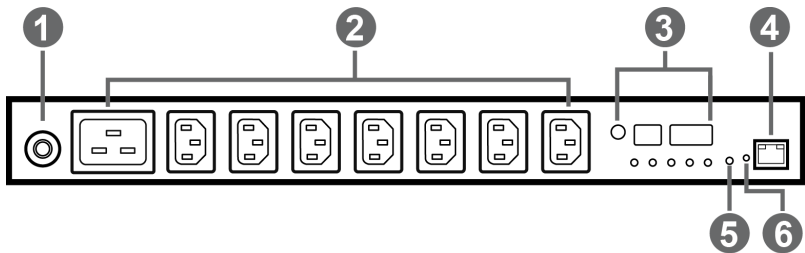
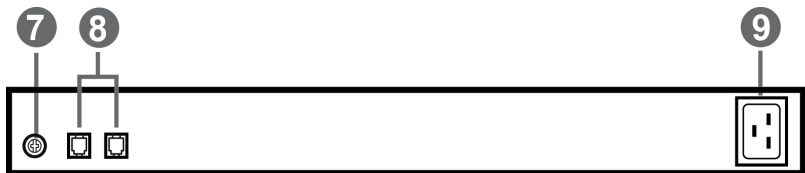
**PE5108B / PE5108G / PE7108B / PE7108G Front View****PE5208B / PE5208G / PE7208B / PE7208G Front View****PE5108B / PE5108G / PE5208B / PE5208G / PE7108B /  
PE7108G / PE7208B / PE7208G Rear View**

## **PE5108B / PE5108G / PE5208B / PE5208G / PE7108B / PE7108G / PE7208B / PE7208G Readout Section**

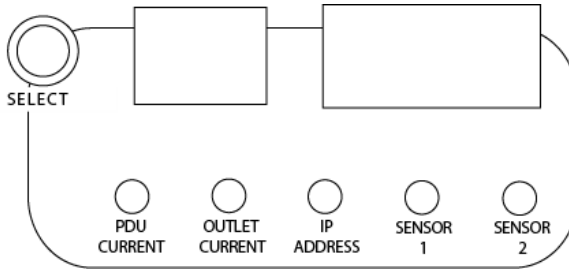

No.	Item	Description
1	circuit breaker pushbutton	As a safety measure, if there is a current overload in regards to the device's power, the circuit breakers will trip. Press the button to recover normal operation.
2	power sockets	8 x IEC60320 C13 or 7 x IEC60320 C13 + 1 x C19 <b>Note:</b> Holes for ATEN Lok-U-Plug cable holders are located around the sockets. See <i>Securing the Cables</i> , page 23, for further information.
3	readout section	<ul style="list-style-type: none"> <li>◆ The selection (PDU Current / Outlet Current / IP Address) appears in the first (1-digit) display window.</li> <li>◆ PDU Current / Outlet Current / IP Address appear in the second (3-digit) display window</li> <li>◆ The LEDs above the items indicate which one the readout relates to.</li> <li>◆ Press the button next to the first display window to cycle the selection among the items.</li> </ul>
4	LAN port and LEDs	The cable that connects the eco PDU to the LAN plugs in here. The Link and LAN LEDs are built into the LAN port: <b>Link:</b> Lights GREEN to indicate that a connection via the eco PDU's RJ-45 Ethernet port has been established. Flashes to indicate data is being transmitted. <b>LAN:</b> Lights ORANGE to indicate 10 Mbps data transmission speed. The LED lights GREEN to indicate 100 Mbps data transmission speed.
5	reset button	This button is recessed and must be pushed with a thin object, such as the end of a paper clip. <ul style="list-style-type: none"> <li>◆ Press and release to reboot the device.</li> <li>◆ Press and hold for more that three seconds to reset the eco PDU to its factory default settings</li> </ul>



No.	Item	Description
6	power LED	The LED lights when the eco PDU is ready to operate.
7	grounding terminal	The wire used to ground the unit connects here.
8	sensor ports	External sensors plug into these two RJ-11 ports.
9	power socket	The power cord that connects the unit to an AC power source plugs in here.

### PE6108A / PE8108A Front View

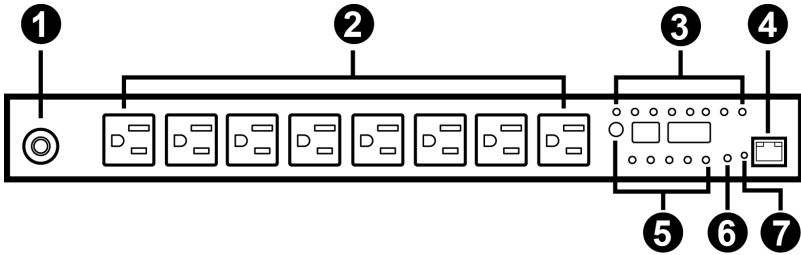

### PE6208A / PE8208A Front View

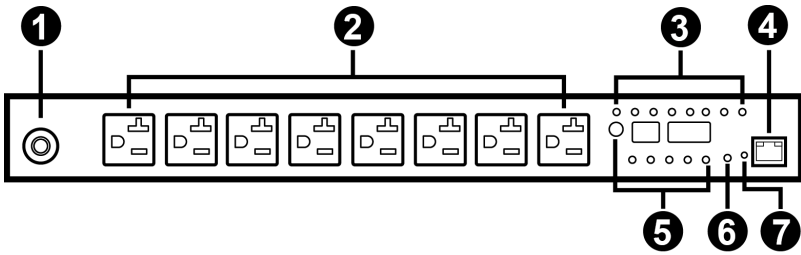

### PE6108A / PE6208A / PE8108A / PE8208A Rear View

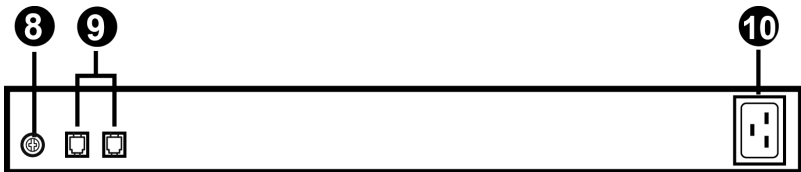

## PE6108A / PE6208A / PE8108A / PE8208A Readout Section

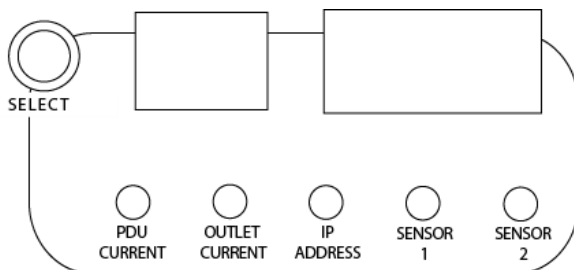

No.	Item	Description
1	circuit breaker pushbutton	As a safety measure, if there is a current overload in regards to the device's power, the circuit breakers will trip. Press the button to recover normal operation.
2	power sockets	8 x NEMA 5-15R or 8 x NEMA 5-20R <b>Note:</b> Holes for ATEN Lok-U-Plug cable holders are located around the sockets. See <i>Securing the Cables</i> , page 23, for further information.
3	outlet status LEDs	These LEDs indicate outlet status. Lights orange for powered on. Off for powered off.
4	LAN port and LEDs	The cable that connects the eco PDU to the LAN plugs in here. The Link and LAN LEDs are built into the LAN port: <b>Link:</b> Lights GREEN to indicate that a connection via the eco PDU's RJ-45 Ethernet port has been established. Flashes to indicate data is being transmitted. <b>LAN:</b> Lights ORANGE to indicate 10 Mbps data transmission speed. The LED lights GREEN to indicate 100 Mbps data transmission speed.
5	readout section	<ul style="list-style-type: none"> <li>◆ The selection (PDU Current / Outlet Current / IP Address) appears in the first (1-digit) display window.</li> <li>◆ PDU Current / Outlet Current / IP Address appear in the second (3-digit) display window</li> <li>◆ The LEDs above the items indicate which one the readout relates to.</li> <li>◆ Press the button next to the first display window to cycle the selection among the items.</li> </ul>

No.	Item	Description
6	reset button	<p>This button is recessed and must be pushed with a thin object, such as the end of a paper clip.</p> <ul style="list-style-type: none"><li>◆ Press and release to reboot the device.</li><li>◆ Press and hold for more than three seconds to reset the eco PDU to its factory default settings</li></ul>
7	power LED	The LED lights when the eco PDU is ready to operate.
8	grounding terminal	The wire used to ground the unit connects here.
9	sensor ports	External sensors plug into these two RJ-11 ports.
10	power socket	The power cord that connects the unit to an AC power source plugs in here.

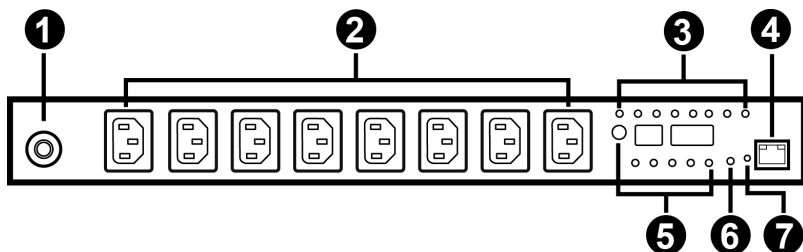
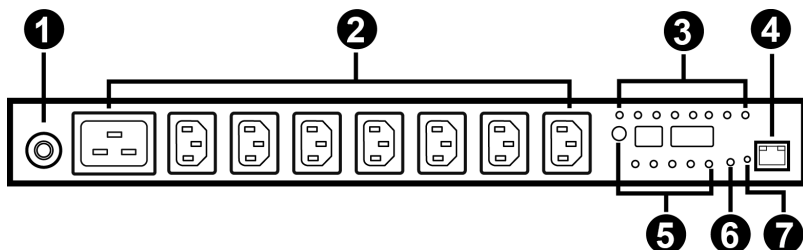
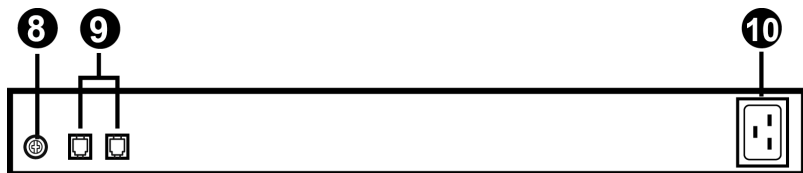
**PE6108B / PE6108G / PE8108B / PE8108G Front View****PE6208B / PE6208G / PE8208B / PE8208G Front View****PE6108B / PE6108G / PE6208B / PE6208G / PE8108B /  
PE8108G / PE8208B / PE8208G Rear View**

## **PE6108B / PE6108G / PE6208B / PE6208G / PE8108B / PE8108G / PE8208B / PE8208G Readout Section**

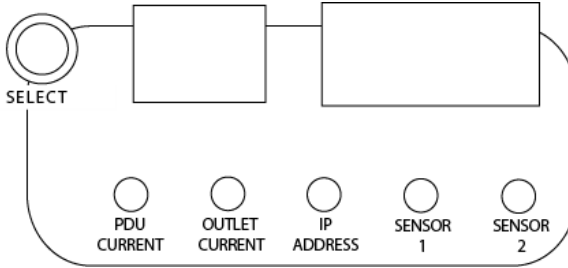

No.	Item	Description
1	circuit breaker pushbutton	As a safety measure, if there is a current overload in regards the device's power, the circuit breakers will trip. Press the button to recover normal operation.
2	power sockets	8 x IEC320 C13 <b>or</b> 7 x IEC320 C13 + 1 x C19 <b>Note:</b> Holes for ATEN Lok-U-Plug cable holders are located around the sockets. See <i>Securing the Cables</i> , page 23, for further information.
3	outlet status LEDs	These LEDs indicate outlet status. Lights orange for powered on. Off for powered off.
4	LAN port and LEDs	The cable that connects the eco PDU to the LAN plugs in here. The Link and LAN LEDs are built into the LAN port: <b>Link:</b> Lights GREEN to indicate that a connection via the eco PDU's RJ-45 Ethernet port has been established. Flashes to indicate data is being transmitted. <b>LAN:</b> Lights ORANGE to indicate 10 Mbps data transmission speed. The LED lights GREEN to indicate 100 Mbps data transmission speed.
5	readout section	<ul style="list-style-type: none"> <li>◆ The selection (PDU Current / Outlet Current / IP Address) appears in the first (1-digit) display window.</li> <li>◆ PDU Current / Outlet Current / IP Address appear in the second (3-digit) display window</li> <li>◆ The LEDs above the items indicate which one the readout relates to.</li> <li>◆ Press the button next to the first display window to cycle the selection among the items.</li> </ul>

---

No.	Item	Description
6	reset button	This button is recessed and must be pushed with a thin object, such as the end of a paper clip. <ul style="list-style-type: none"><li>◆ Press and release to reboot the device.</li><li>◆ Press and hold for more than three seconds to reset the eco PDU to its factory default settings</li></ul>
7	power LED	Lights when the unit is powered up and ready to operate.
8	grounding terminal	The wire used to ground the unit connects here.
9	sensor ports	External sensors plug into these two RJ-11 ports.
10	power socket	The power cord that connects the unit to an AC power source plugs in here.

---

This Page Intentionally Left Blank



# Chapter 2

## Hardware Setup

### Before You Begin

---



1. Important safety information regarding the placement of this device is provided on page 63. Please review it before proceeding.
2. Make sure that power to all the devices you will be connecting have been turned off. You must unplug the power cords of any computers that have the Keyboard Power On function.



1. Vous trouverez des informations de sécurité importantes concernant le positionnement de l'unité à la page 63. Veuillez les lire attentivement avant d'aller plus loin.
2. Vérifiez que tous les périphériques à connecter sont éteints. Vous devez débrancher les câbles d'alimentation des ordinateurs disposant de la fonction de mise sous tension à partir du clavier.

### Rack Mounting

---

The eco PDU can be mounted in a 19" (1U) rack. To rack mount the device, use the rack mounting brackets that came with your device. The brackets can be screwed to the front or rear sides of the device, and then the unit can slide into the front of the rack, as shown in the diagram below:

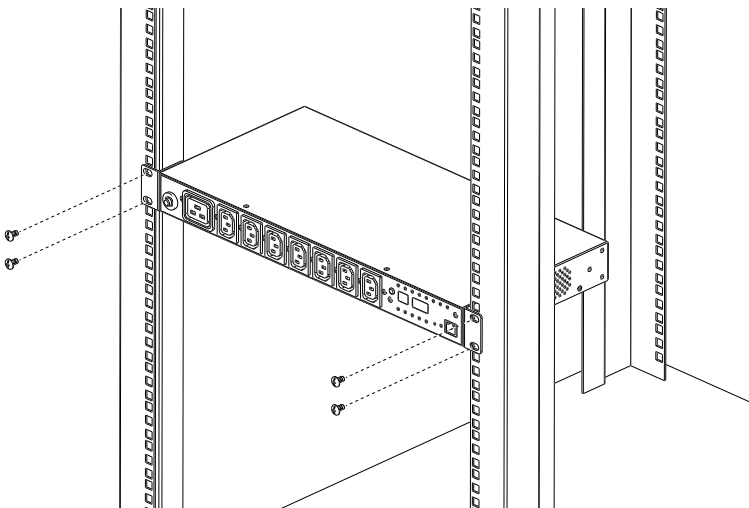

## Installation

---

To set up your eco PDU installation, refer to the installation diagram on the next page (the numbers in the diagram correspond to the numbered steps), and do the following:

1. Use a grounding wire to ground the eco PDU by connecting one end of the wire to its grounding terminal, and the other end of the wire to a suitable grounded object.

---

**Note:** Do not omit this step. Proper grounding helps to prevent damage to the unit from surges or static electricity.

---

2. For each device you want to connect, use its power cable to connect from the device's AC socket to any available outlet on the eco PDU.
3. Plug the cable that connects the eco PDU to the LAN into the eco PDU's LAN port.
4. If you are using sensors in your eco PDU installation, connect them to the sensor ports on the unit's rear side panel.

---

**Note:** Sensors are optional. Please see *Optional Accessories*, page 7, and the detailed sensor installation diagrams later in this chapter for further information.

---

5. Connect the eco PDU's power cord to an AC power source.

---

**Note:** We strongly advise that you do not plug the eco PDU into a multi socket extension cord, since it may not receive enough amperage to operate correctly.

---

Once you have finished these installation steps, you can turn on the eco PDU and the connected devices.

---

**Note:** We strongly recommend using cable ties and cable bars to safely and securely route the cables attached to the front of the unit.

---

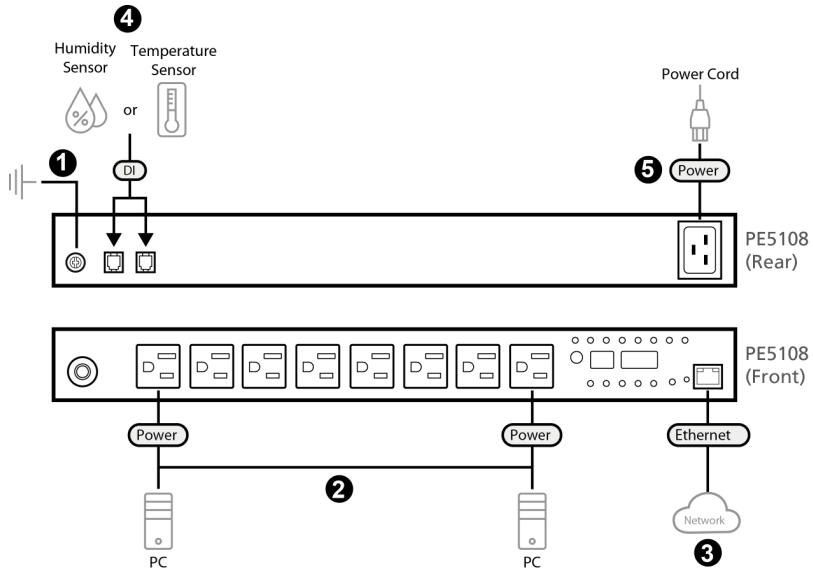

## Securing the Cables

For added safety, use ATEN Lok-U-Plug cable holders to secure the cables from your attached devices in place on the eco PDU unit. Secure the cable holders using the specially designed holes around the individual power outlets, as shown below:

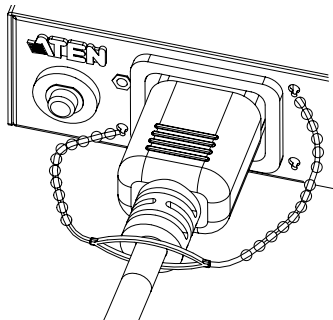

**Note:** 1. Cable holders are an optional accessory. See *Cable Holders*, page 7.

2. Use only the ATEN Lok-U-Plug cable holders that have been specifically designed to work with the eco PDU. Using any other kind of cable securing device could be highly dangerous.

## **Securing the Sensors**

Connect the sensors to the eco PDU's front panel sensor ports and secure them using sensor mounts, tie wraps, and adhesive cable tie holders. If you use a tie wrap to secure the sensor, tighten the tie wrap over the recessed channel on the sensor, as shown in the following diagram:

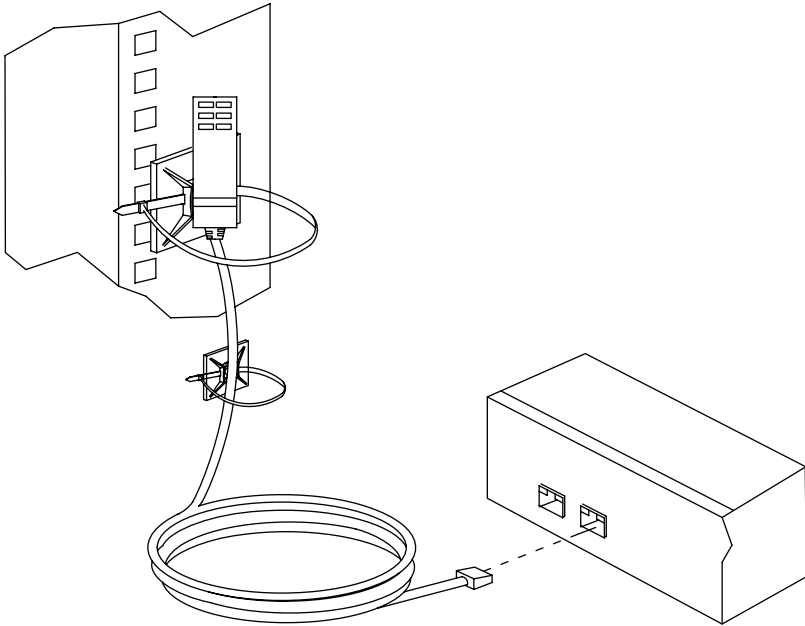

- 
- Note:**
1. The sensors shown in the above diagram are for reference purposes only. The sensors for the eco PDU may look slightly different.
  2. Depending on the model and type of sensor, sensor mounts, tie wraps, and adhesive cable tie holders may or may not be provided in the package.
-

# Chapter 3

## Basic Operation and First Time Setup

### Operation Methods

---

ATEN eco PDU models provide three methods to access and manage your installation: Browser, eco DC (Energy & DCIM Management Web GUI), and SNMP.

---

**Note:** The following sections of this chapter contain information concerning browser operation. For eco DC operation, please reference the separate eco DC User Manual. The eco DC web GUI and the user manual can be downloaded from the ATEN website.

---

### **Browser**

The eco PDU can be accessed and controlled via any supported Internet browser from any platform.

To operate the eco PDU from an Internet browser, begin by logging in:

1. Open your browser, and specify the IP address of the eco PDU you want to access in the browser's URL location bar.

---

**Note:** The default IP address is *192.168.0.60*. You can get the IP address from the eco PDU administrator, or see *IP Address Determination*, page 73.

---

2. If a security alert appears, accept the certificate—it can be trusted. The login page appears.
3. Provide a valid username and password.

---

**Note:** If you are logging in for the first time, use the default login credentials *administrator* and *password*.

---

4. Click **Login** to bring up the browser main page.

## **eco DC**

All eco PDUs support eco DC (Energy & DCIM Management Web GUI). eco DC provides you with an easy method for managing multiple devices, offering an intuitive and user-friendly GUI that allows you to configure eco PDUs and monitor power status of all equipments connected. To install the software, visit the product web page, and then download the installer from the Support and Downloads tab.

## **SNMP**

eco PDUs support any 3rd party V1, V2 & V3 SNMP Manager Software. To install the software, visit the product web page, and then download the installer from the Support and Downloads tab.

## First Time Setup

Once the eco PDU installation has been cabled up, the next task the administrator needs to perform involve configuring the network parameters, changing the default super administrator login settings, and adding users.

The way to accomplish this is to log in over the Net with a browser.

- Note:**
1. Since this is the first time you are logging in, use the default username: *administrator*; and the default password: *password*. For security purposes we recommend changing them to something unique (see *Changing the Administrator Login*, page 29).
  2. For remote methods of getting logged in to the network, see *IP Address Determination*, page 73.

After you successfully log in, the eco PDU Energy/Connections page appears:

The screenshot displays the ATEN NRGOffice PDU configuration interface. The top navigation bar includes 'Energy', 'User', 'Log', 'Setup', and 'PDU'. The main content area is titled 'Connections | Configuration' and features a sidebar with a tree view of PDU units (P1-P4). The primary view shows two tables: 'PDU Status' and 'Outlet Status'.

**PDU Status Table:**

PDU Name	Measurement	Min Threshold	Max Threshold	PDU Status	
PE108A	Aggregate current	0.00 A			
	Voltage	82.85 V			
	Power	0.0000 W			
	Aggregate power dissipation	0.0000 kWh			
	Breaker	ON			
	Voltage frequency	59.88 HZ			
	Sensor1	Temperature	N/A		<input type="checkbox"/> ON <input type="checkbox"/> Reboot <input type="checkbox"/> OFF
		Humidity	N/A		
		Pressure	N/A		
	Sensor2	Temperature	N/A		
	Humidity	N/A			
	Pressure	N/A			

**Outlet Status Table:**

Outlet	Outlet Name	Measurement	Min Threshold	Max Threshold	Outlet Status
P1		Current	0.00 A		
		Voltage	110.30 V		
		Power	0.0000 W		
		Power Dissipation	0.0000 kWh		
P2		Current	0.00 A		
		Voltage	110.38 V		
		Power	0.0000 W		
		Power Dissipation	0.0000 kWh		
P3		Current	0.00 A		
		Voltage	110.59 V		
		Power	0.0000 W		
		Power	0.0000 W		

© Copyright 2012 ATEN International Co., Ltd.

**Note:** Operation details are discussed in *Energy*, page 34, in the next chapter. For further setup information, continue with this chapter

## Network Configuration

To set up the network, do the following:

1. Click the **Setup** tab.
2. The interface displays the **Device Configuration** page. A screen similar to the one below appears:

The screenshot displays the NRCence PE8108B web interface. The top navigation bar includes icons for Energy, User, Log, Setup (highlighted with a red circle), and PDU. The main content area is titled "Device Configuration | Security". On the left, a sidebar shows a list of ports [01] through [08]. The main configuration area is divided into three sections:

- General**:
  - PDU Name: PE1108A
  - MAC Address: 00:10:74:9D:01:01
  - Firmware Version: FW Ver:1.1.133
  - Rack Location name: PE1108A
- Service Ports**:
  - Radio buttons:  Only HTTPs,  HTTP / HTTPs
  - HTTP: 80
  - HTTPs: 443
- IPv4 Configuration**:
  - Radio buttons:  Obtain IP address automatically [DHCP],  Set IP address manually [Fixed IP]
  - IP Address: 10.3.55.74
  - Subnet Mask: 255.255.254.0
  - Default Gateway: 10.3.57.254
  - Radio buttons:  Obtain DNS server address automatically,  Set DNS server address manually
  - Preferred DNS Server: 10.0.1.7
  - Alternate DNS Server: 10.0.1.8

3. Fill in the fields according to the information provided under *Device Configuration*, page 44.



## Changing the Administrator Login

To change the default administrator username and password, do the following:

1. Click the **User** tab.

The *Accounts* page has a detailed list of users—with more information about them—in the large central panel:

The screenshot shows the NRGence PE8108B Accounts page. The 'User' tab is highlighted with a red circle. The page displays the following information:

**Administrator information**

**Administrator:**

Name: administrator Password: ●●●●●●

**SNMPv3 account information**

Name: administrator Auth-password: ●●●●●●

**SNMPv1/v2c community**

Read community: administrator Write community: administrator

**User information**

Management	Name	Password
Enable ▼	asdfdf	●●●●
Enable ▼	fefefef	●●●●●●
Enable ▼	brett	●●●●●●
Disable ▼		
Disable ▼		
Disable ▼		
Disable ▼		

2. In the **Administrator Information** section, reset the name and password fields to something unique, then click **Save** (at the bottom of the page.)

**Note:** If you forget the administrator's name or password, short the mainboard jumper to restore the default administrator account. See *Administrator Login Failure*, page 81 in the Appendix for full details.

## Moving On

After setting up the network and changing the default administrator username and password, you can proceed to other administration activities—including adding users. This is covered in the next chapter.

This Page Intentionally Left Blank

# Chapter 4

## Browser Operation

### Logging In

---

The eco PDU can be accessed via a supported Internet browser from any platform.

---

**Note:** Browsers must support TLS 1.2.

---

To access the eco PDU do the following:

1. Open your browser and specify the IP address of the eco PDU you want to access in the browser's URL location bar.

---

**Note:** You can get the IP address from the eco PDU administrator, or see *IP Address Determination*, page 73, for information about setting it up yourself.

---

2. If a security alert dialog box appears, accept the certificate—it can be trusted. The Login page appears:

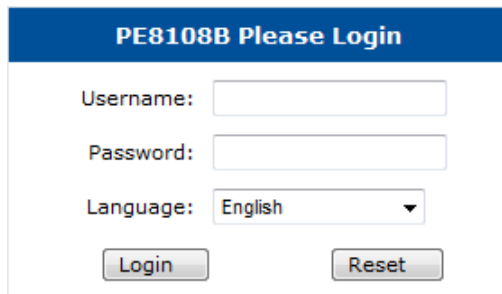

The image shows a web browser window displaying a login page for a device labeled 'PE8108B'. The page has a blue header with the text 'PE8108B Please Login'. Below the header, there are three input fields: 'Username:', 'Password:', and 'Language:'. The 'Language:' field is a dropdown menu with 'English' selected. At the bottom, there are two buttons: 'Login' and 'Reset'.

3. Provide a valid username and password (set by the eco PDU administrator), and select your language. (Options are: English [default]; Traditional Chinese; Simplified Chinese; Japanese; German; Italian; Spanish; French).
4. Click **Login** to bring up the browser main page.

# The eco PDU Main Page

After you have successfully logged in, the eco PDU main page comes up with the Energy *Connections* page displayed:

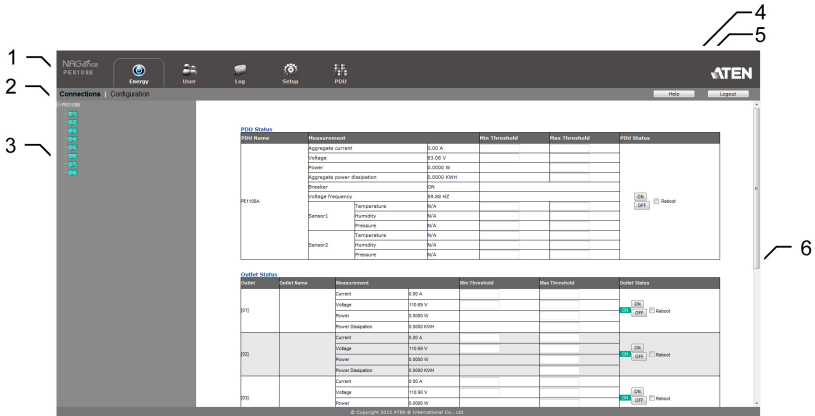

**Note:** The screen depicts an administrator’s page. Depending on a user’s type and permissions, not all of these elements appear.

## Page Components

The web page screen components are described in the table, below:

No.	Item	Description
1	Tab Bar	The tab bar contains the eco PDU's main operation categories. The items that appear in the tab bar are determined by the user's type, and the authorization options that were selected when the user's account was created.
2	Menu Bar	The menu bar contains operational subcategories that pertain to the item selected in the tab bar. The items that appear in the menu bar are determined by the user's type, and the authorization options that were selected when the user's account was created.
3	Sidebar	The sidebar provides a tree view listing of outlets that relate to the various tab bar and menu bar selections.
4	Help	Connects to on-line help at the ATEN website for the device's configuration and operation.
5	Logout	Click this button to log out of your eco PDU session.
6	Interactive Display Panel	This is your main work area. The screens that appear reflect your menu choices and the sidebar node selection.

# Energy

## Connections

When you log in to the eco PDU, the interface opens with its default selection of the *Energy* tab; and the *Connections* menu. The contents of the **PDU Status** and **Outlet Status** sections are displayed in the main panel.

The screenshot shows the ATEN eco PDU web interface. At the top, there is a navigation bar with 'Energy', 'User', 'Log', 'Setup', and 'PDU' tabs. The 'Energy' tab is selected. Below the navigation bar, there are 'Connections' and 'Configuration' buttons, along with 'Help' and 'Logout' buttons. On the left side, there is a vertical list of outlet numbers from 01 to 06. The main content area is divided into two sections: 'PDU Status' and 'Outlet Status'.

**PDU Status**

PDU Name	Measurement	Min Threshold	Max Threshold	PDU Status	
PE1100A	Aggregate current	0.00 A			
	Voltage	32.85 V			
	Power	0.0000 W			
	Aggregate power dissipation	0.0000 KWH			
	Breaker	ON			
	Voltage frequency	59.88 HZ			
	Sensor1	Temperature	N/A		<input type="checkbox"/> ON <input type="checkbox"/> OFF <input type="button" value="Reboot"/>
		Humidity	N/A		
		Pressure	N/A		
	Sensor2	Temperature	N/A		
	Humidity	N/A			
	Pressure	N/A			

**Outlet Status**

Outlet	Outlet Name	Measurement	Min Threshold	Max Threshold	Outlet Status
01		Current	0.00 A		
		Voltage	110.38 V		
		Power	0.0000 W		
		Power Dissipation	0.0000 KWH		
02		Current	0.00 A		
		Voltage	110.30 V		
		Power	0.0000 W		
		Power Dissipation	0.0000 KWH		
03		Current	0.00 A		
		Voltage	110.58 V		
		Power	0.0000 W		

© Copyright 2012 ATEN® International Co., Ltd.

**Note:** Only enabled eco PDU models will display the Outlet Status submenu section. Other models provide only PDU Status monitoring. See *PE Series eco PDU Comparison Chart*, page 3, for which models support PDU and Outlet Status or PDU Status only monitoring.

## PDU Status

All eco PDU models support PDU device level monitoring. The **PDU Status** section allows you to set up a power management configuration for the PDU device as a whole:

### PDU Status

PDU Name	Measurement	Value	Min Threshold	Max Threshold	PDU Status	
PE1108A	Aggregate current	0.00 A			<input type="button" value="ON"/> <input type="button" value="OFF"/> <input type="checkbox"/> Reboot	
	Voltage	82.71 V				
	Power	0.0000 W				
	Aggregate power dissipation	0.0000 KWH				
	Breaker	ON				
	Voltage frequency	59.88 HZ				
	Sensor1	Temperature	N/A			
		Humidity	N/A			
		Pressure	N/A			
	Sensor2	Temperature	N/A			
		Humidity	N/A			
		Pressure	N/A			

### ■ PDU Threshold Settings

These fields are used to set the maximum, minimum, and fluctuation threshold settings for Aggregate Current, Voltage, Power, and Aggregate Power Dissipation. If a range falls below the minimum setting, or exceeds the maximum setting an alarm is triggered.

- ◆ **Breaker** status (ON / OFF) displays here.
- ◆ **Voltage Frequency** is displayed here in Hz.
- ◆ **On / Off / Reboot**

You can manually turn the device On and Off from this page by clicking the buttons.

If you wish to reboot the device, check the Reboot checkbox and click the **Off** button beside the checkbox.

- ◆ **Sensor 1 / Sensor 2**

If you have sensors installed in your installation, use these fields to set the maximum, minimum, and fluctuation threshold settings for Temperature, Humidity, and Differential Pressure.

---

**Note:** Sensors are optional accessories. Check with your dealer for details.

---

## Outlet Status

If your eco PDU model(s) supports outlet level monitoring, the main panel Outlet Status section allows you to set up a power management configuration for each outlet at an individual level.

### Outlet Status

Outlet	Outlet Name	Measurement	Min Threshold	Max Threshold	Outlet Status	
[01]		Current	0.00 A	<input type="text"/>	<input type="text"/>	
		Voltage	110.57 V	<input type="text"/>	<input type="text"/>	ON <input type="button" value="ON"/> <input type="button" value="OFF"/> <input type="checkbox"/> Reboot
		Power	0.0000 W	<input type="text"/>	<input type="text"/>	
		Power Dissipation	0.0000 KWH	<input type="text"/>	<input type="text"/>	
[02]		Current	0.00 A	<input type="text"/>	<input type="text"/>	
		Voltage	110.57 V	<input type="text"/>	<input type="text"/>	ON <input type="button" value="ON"/> <input type="button" value="OFF"/> <input type="checkbox"/> Reboot
		Power	0.0000 W	<input type="text"/>	<input type="text"/>	
		Power Dissipation	0.0000 KWH	<input type="text"/>	<input type="text"/>	

### ■ Outlet Threshold Settings

These fields are used to set the maximum, minimum, and fluctuation threshold settings for Current, Voltage, Power, and Power Dissipation. If a range falls below the minimum setting, or exceeds the maximum setting an alarm is triggered.

### ■ On / Off / Reboot

You can manually turn the outlet On and Off from this page by clicking the buttons. To Reboot the outlet, enable the Reboot checkbox and click on Save (located at the bottom of the page).



## Configuration

The *Configuration* page is used to configure the settings of the eco PDU at the individual power outlet level:

**POP Settings**

Enable POP Mode ( Proactive Overload Protection )

POP Threshold :

Same as Bank Max Current 16 A

User Define :

---

**Power On Time Schedule Settings**

Enable Power On Time Schedule

---

**Buzzer Setting**

Enable Buzzer Alarm

---

**Outlet Configuration**

Outlet	Outlet Name	Confirmation Required	Delay Time (sec)		Remote Turn ON Method
			Power ON	Power OFF	
[01]	<input type="text"/>	<input checked="" type="checkbox"/>	S <input type="text"/>	1 <input type="text"/>	Method: Kill the Power MAC Address: <input type="text"/>
[02]	<input type="text"/>	<input checked="" type="checkbox"/>	S <input type="text"/>	1 <input type="text"/>	Method: Kill the Power MAC Address: <input type="text"/>
[03]	<input type="text"/>	<input checked="" type="checkbox"/>	S <input type="text"/>	1 <input type="text"/>	Method: Kill the Power MAC Address: <input type="text"/>
[04]	<input type="text"/>	<input checked="" type="checkbox"/>	S <input type="text"/>	1 <input type="text"/>	Method: Kill the Power MAC Address: <input type="text"/>
[05]	<input type="text"/>	<input checked="" type="checkbox"/>	S <input type="text"/>	1 <input type="text"/>	Method: Kill the Power MAC Address: <input type="text"/>
[06]	<input type="text"/>	<input checked="" type="checkbox"/>	S <input type="text"/>	1 <input type="text"/>	Method: Kill the Power MAC Address: <input type="text"/>
[07]	<input type="text"/>	<input checked="" type="checkbox"/>	S <input type="text"/>	1 <input type="text"/>	Method: Kill the Power MAC Address: <input type="text"/>
[08]	<input type="text"/>	<input checked="" type="checkbox"/>	S <input type="text"/>	1 <input type="text"/>	Method: Kill the Power MAC Address: <input type="text"/>

### ■ POP Settings

This section allows you to configure the settings for the Proactive Overload Protection (POP) feature. Effective on all non-critical outlets, this added safety feature automatically powers off outlets in the user-defined sequence when a current overload occurs in protecting the powered devices.

- ◆ **Enable POP Mode** by clicking the radio button
- ◆ Make your selection for the **POP Threshold**—options are *Same as Bank Maximum Current* or *User Defined*—enter a value in the field.

---

**Note:** This feature is available on PE6108, PE6208, PE8108 and PE8208 models only.

---

*(Continues on next page.)*

## ■ Power On Time Schedule Settings

Check the **Enable Power On Time Schedule** box to use the *Power ON Delay* setting to set the amount of time the eco PDU waits before powering on an outlet. See *Power ON Delay* in the table below.

## ■ Buzzer Setting

Checking the **Enable Buzzer Alarm** box sounds an alarm and sends SNMP trap or e-mail alerts when a circuit breaker trips or a PDU/Outlet threshold setting exceeds the minimum or maximum setting.

## ■ Outlet Configuration

The *Outlet Configuration* section lets you set the power management settings for each outlet on the PDU.

Heading	Meaning
Outlet Name	Each outlet can be given a distinctive name. The maximum number of characters is 15.
Confirmation Required	If this option is enabled (there is a check in the checkbox), a dialog box comes up asking you to confirm a power operation before it is performed. If it is disabled (there is no check in the checkbox), the operation is performed without confirmation.
Power ON Delay	<p>Sets the amount of time the eco PDU waits after the power button is clicked (see <i>Outlet Status</i>, page 36), before it turns on the power to the outlet. You must check the <i>Enable Power On Time Schedule Setting</i> box for this setting to take effect. See <i>Power On Time Schedule Settings</i>, page 38, for details.</p> <p><b>Note:</b> The default delay time is 0 seconds; the maximum is 999 seconds. When a series of outlets are scheduled to be powered up, they turn on in sequence with a default delay of 10 milliseconds between each outlet.</p>
Power OFF Delay	<p>Sets the amount of time the eco PDU waits after the Power Button is clicked (see <i>Outlet Status</i>, page 36), before it turns off the power to the outlet.</p> <p>For the <i>System after AC Back</i> option (see below), after the delay time expires, the eco PDU waits another fifteen seconds, then shuts the computer down.</p> <p>The default delay time is 15 seconds. The maximum delay time is 999 seconds.</p>

Heading	Meaning
Remote Turn ON Method	<p>Use the drop-down menu to select one of the choices, below:</p> <p><b>Wake on LAN:</b> This is a safe shutdown and restart option. If this is selected, when an outlet is turned off, the eco PDU first sends a message to the computer telling it to prepare for a shutdown; it then waits for the amount time set in the <i>Power Off Delay</i> field to give the OS time to close down before the computer is powered down to standby mode.</p> <p>Likewise, when the outlet is turned on, the eco PDU waits for the amount time set in the <i>Power On Delay</i> field, then sends an Ethernet message to the computer connected to the outlet telling the computer to turn itself on.</p> <p><b>Note:</b> For safe shutdown and restart, the computer must be running Windows (98 or higher), or Linux, and the <i>Safe Shutdown</i> program (available by download from our website), must be installed and running on the computer.</p> <p><b>System after AC Back:</b> This is a safe shutdown and restart option. If this is selected, when an outlet is turned off, the eco PDU first sends a message to the computer telling it to prepare for a shutdown; it then waits for the amount time set in the <i>Power Off Delay</i> field to give the OS time to close down before the computer is powered down.</p> <p>When the outlet is turned on, the eco PDU waits for the amount time set in the <i>Power On Delay</i> field, then sends power to the server. When the server receives the power, it turns itself on.</p> <p><b>Note:</b> For safe shutdown and reboot, the computer must be running Windows (98 or higher), or Linux, and the <i>safe shutdown</i> program (available by download from our website), must be installed and running on the computer.</p> <p><b>Kill the Power:</b> If this option is selected, the eco PDU waits for the amount time set in the <i>Power Off Delay</i> field, and then turns the outlet's power off. Turning the power off performs a cold (non-safe) shutdown.</p>
MAC Address	<p>In order to use either of the safe shutdown and restart methods the MAC address of the computer connected to the outlet must be filled in here.</p>

When you have finished making your configuration settings, click **Save**.

## User

When you select the *User* tab the screen comes up with *Administrator Information* and *User Information* displayed in the main panel. The eco PDU supports one administrator account and up to eight user accounts.

- Note:**
1. Each account can support 2 login sessions
  2. The eco PDU supports a total of 3 concurrent login sessions.

**Administrator information**

Administrator:

Name: administrator Password: \*\*\*\*\*

**SNMPv3 account information**

Name: administrator Auth-password: \*\*\*\*\* Priv-Password: \*\*\*\*\*

**SNMPv1/v2c community**

Read community: administrator Write community: administrator

---

**User information**

Management	Name	Password	Outlet											
			All	01	02	03	04	05	06	07	08			
Enable ▾	asdfof	*****	🔒	🔒	🔒	🔒	🔒	🔒	🔒	🔒	🔒	🔒	🔒	🔒
Enable ▾	fefofef	*****	🔒	🔒	🔒	🔒	🔒	🔒	🔒	🔒	🔒	🔒	🔒	🔒
Enable ▾	brett	*****	🔒	🔒	🔒	🔒	🔒	🔒	🔒	🔒	🔒	🔒	🔒	🔒
Disable ▾			🔒	🔒	🔒	🔒	🔒	🔒	🔒	🔒	🔒	🔒	🔒	🔒
Disable ▾			🔒	🔒	🔒	🔒	🔒	🔒	🔒	🔒	🔒	🔒	🔒	🔒
Disable ▾			🔒	🔒	🔒	🔒	🔒	🔒	🔒	🔒	🔒	🔒	🔒	🔒
Disable ▾			🔒	🔒	🔒	🔒	🔒	🔒	🔒	🔒	🔒	🔒	🔒	🔒
Disable ▾			🔒	🔒	🔒	🔒	🔒	🔒	🔒	🔒	🔒	🔒	🔒	🔒
Disable ▾			🔒	🔒	🔒	🔒	🔒	🔒	🔒	🔒	🔒	🔒	🔒	🔒

**Note:** There is a pre-installed administrator account. It can be used to set up the device and to begin creating users and groups. The username for this account is *administrator*; the password is *password*. For security purposes, we strongly recommend changing these to something unique.

### Administrator Information

This section is used to set the administrator name and password. Only administrators can view this section. For details, see *Changing the Administrator Login*, page 29.

### SNMPv3 Account Information

- ♦ Enter values for **Name**, **Auth-Password** and **Priv-Password** for SNMPv3 authentication, if required.

### SNMPv1/V2c Community

- ♦ Enter values **Read community** and **Write community** for SNMPv1/V2c authentication, if required.

## User Information

To add a user, do the following:









1. Select the user type in the Management drop-down menu.
2. Key in a name and password in the Name and Password fields.
3. Set the outlet-by-outlet permissions of the user in the Outlet field.
4. Set the Management field to *Enable*.
5. Click *Save* to save your settings.

---

**Note:** Values must be entered in both the Name and Password fields in order to enable an account.

---

The various options are explained in more detail in the following table:

Field	Description						
Management	<p>The Management field allows you to enable or disable a user's account:</p> <ul style="list-style-type: none"> <li>◆ Enable: Stores the user account (see <i>User Information</i>, page 41)</li> <li>◆ Disable: Disables the user account</li> </ul>						
Name	From 1 to 16 characters are allowed depending on the Account Policy settings. See <i>Account Policy</i> , page 53.						
Password	From 1 to 16 characters are allowed depending on the Account Policy settings. See <i>Account Policy</i> , page 53.						
Outlet	<p>This field allows you to set the outlet-by-outlet permissions of the user. Click on the user/port icon to cycle through the three permissions options, as follows:</p> <table border="1"> <tbody> <tr> <td></td> <td>User has complete access to this outlet.</td> </tr> <tr> <td></td> <td>User has read-only access to this outlet.</td> </tr> <tr> <td></td> <td>User has no access to this outlet.</td> </tr> </tbody> </table>		User has complete access to this outlet.		User has read-only access to this outlet.		User has no access to this outlet.
	User has complete access to this outlet.						
	User has read-only access to this outlet.						
	User has no access to this outlet.						
Save	Click this button to save your operation or changes						

## Log

The *Log* tab keeps a record of transactions that take place on its installation, and stores up to 128 events at one time. The *System Log* page provides a powerful array of filters and functions that allow you to view and export the log file data, as well as be informed by email of specified events as they occur.

Refresh 25 Event(s) per Page Page 1 of 6

No.	Date/Time	Category	Severity	User	Description
001	2014-07-16 23:44:10	Device	Information	administrator	Bank 1 name was changed by administrator.
002	2014-07-16 23:43:52	Device	Information	administrator	Bank 1 name was changed by administrator.
003	2014-07-16 23:01:22	Device	Information		Outlet 6 was turned OFF.
004	2014-07-16 23:01:21	Device	Information	administrator	OFF command issued to Outlet 6 by administrator.
005	2014-07-16 23:01:13	Device	Information		Outlet 3 was turned OFF.
006	2014-07-16 23:01:12	Device	Information	administrator	OFF command issued to Outlet 3 by administrator.
007	2014-07-16 23:01:06	Device	Information		Outlet 1 was turned OFF.
008	2014-07-16 23:01:05	Device	Information	administrator	OFF command issued to Outlet 1 by administrator.
009	2014-07-16 21:33:21	User Management	Information	administrator	User (Username: as) access rights were modified by administrator.
010	2014-07-16 21:33:21	User Management	Information	administrator	User (Username: ds) access rights were modified by administrator.
011	2014-07-16 21:33:21	User Management	Information	administrator	User (Username: ff) access rights were modified by administrator.
012	2014-07-16 21:32:41	User Management	Information	administrator	User (Username: as) access rights were modified by administrator.
013	2014-07-16 21:31:29	Authentication	Information	administrator	administrator 10.3.41.62 logged in.
014	2014-07-16 20:39:33	Authentication	Information	administrator	administrator 10.3.52.74 logged out.
015	2014-07-16 14:40:19	Device	Information	administrator	Outlet 24 name was changed by administrator.
016	2014-07-16 14:40:19	Device	Information	administrator	Outlet 23 name was changed by administrator.
017	2014-07-16 14:40:18	Device	Information	administrator	Outlet 22 name was changed by administrator.

## The System Log Event List

- ◆ Clicking on a device in the sidebar displays its log events in the main panel's log event list.
- ◆ Clicking the **Refresh** button brings the log list up to date with the latest events.
- ◆ The entry box to the right of the Refresh button lets you set the number of events to display per page. Simply key in the number of your choice.
- ◆ The top right of the main panel shows the total number of pages in the log file, and what page you are currently viewing.
- ◆ The buttons on the bottom row function as follows:
  - ◆ **Clear:**  
Click to erase the contents of the log event list
  - ◆ **First Page:**  
Click to go to the first page of the log event list
  - ◆ **Previous Page:**  
Click to move to the previous page of the log event list
  - ◆ **Next Page:**  
Click to move to the next page of the log event list

- ◆ **Last Page:**  
Click to move to the last page of the log event list
- ◆ **Export Log:**  
Click to save the contents of the log event list to file.

## Notification Settings

The *Notification Settings* page is used to specify which of the eco PDU's components will receive notification of a log event. When you click the Notification Settings menu item, a page similar to the one below appears:

Event Log Settings			
Event List			
Event	Syslog	E-mail	SNMP
Enable all system events	<input type="checkbox"/>	<input type="checkbox"/>	<input type="checkbox"/>
Log export succeeded	<input checked="" type="checkbox"/>	<input checked="" type="checkbox"/>	<input checked="" type="checkbox"/>
System event log (SEL) cleaned	<input checked="" type="checkbox"/>	<input checked="" type="checkbox"/>	<input checked="" type="checkbox"/>
FW upgrade succeeded	<input checked="" type="checkbox"/>	<input checked="" type="checkbox"/>	<input checked="" type="checkbox"/>
FW upgrade failed	<input checked="" type="checkbox"/>	<input checked="" type="checkbox"/>	<input checked="" type="checkbox"/>
Device configuration restore succeeded	<input checked="" type="checkbox"/>	<input checked="" type="checkbox"/>	<input checked="" type="checkbox"/>
Device configuration restore failed	<input checked="" type="checkbox"/>	<input checked="" type="checkbox"/>	<input checked="" type="checkbox"/>
Device configuration backup succeeded	<input checked="" type="checkbox"/>	<input checked="" type="checkbox"/>	<input checked="" type="checkbox"/>
Device configuration settings modified	<input checked="" type="checkbox"/>	<input checked="" type="checkbox"/>	<input checked="" type="checkbox"/>
Security settings modified	<input checked="" type="checkbox"/>	<input checked="" type="checkbox"/>	<input checked="" type="checkbox"/>
FW upgrade started	<input checked="" type="checkbox"/>	<input checked="" type="checkbox"/>	<input checked="" type="checkbox"/>
Device rebooted	<input checked="" type="checkbox"/>	<input checked="" type="checkbox"/>	<input checked="" type="checkbox"/>
PDU get new IP address	<input checked="" type="checkbox"/>	<input checked="" type="checkbox"/>	<input checked="" type="checkbox"/>
Enable all Authentication events	<input type="checkbox"/>	<input type="checkbox"/>	<input type="checkbox"/>
Enable all User Management events	<input type="checkbox"/>	<input type="checkbox"/>	<input type="checkbox"/>
Enable all Device Management events	<input type="checkbox"/>	<input type="checkbox"/>	<input type="checkbox"/>

- ◆ The event categories are listed in the left column.
  - ◆ When you first open the page, only the main category items appear. (Main category item rows have a gray background.)
  - ◆ Subcategory items are nested under the main category headings. Click the accordion in front of the main category headings to display the subcategory items. (Subcategory item rows have a white background.)
- ◆ Click the checkboxes under the column headings to select which component(s) will receive notification of the log events.
  - ◆ Clicking on a main category heading's row automatically selects all the subcategory items nested below it.
  - ◆ If you only want to set notification for some of the subcategory events, don't put a check in the main category row. Instead, drop down the subcategory list, and only check the subcategory events you want.
- ◆ When you have finished making your setting choices, click Save. When a specified log event occurs, notification of that event will be sent to the selected component.
- ◆ **Reset Digital Output:**  
If an event has been triggered that changes the digital output sensor from Low to High, click this button to return the sensor to the Low state.

## Setup

The *Setup* tab provides Device Configuration and Security settings. The *Device Configuration* page allows super administrators, administrators, and users with device management permission to configure eco PDU system settings. The *Security* page controls access to the PDU.

### Device Configuration

This page presents information about the selected device, as described in the following sections:

#### General

**General**

PDU Name :

MAC Address : 00:04:A3:1E:FC:19

Firmware Version : 1.0.023 Ver

Rack Location name :

Item	Meaning
PDU Name	This field lets you give the device a unique name. Simply delete whatever is in the text box and key in the name of your choice. Click <b>Save</b> (located at the bottom of the page) to save the new name.
MAC Address	This item displays the eco PDU's MAC address.
Firmware Version	This item displays the current firmware version number. You can reference it to see if there are newer versions available on the ATEN website.
Rack Location Name	This field lets you give the rack location a unique name for easy reference.



## Service Ports

As a security measure, if a firewall is being used, the administrator can specify the port numbers that the firewall will allow. If a port other than the default is used, users must specify the port number as part of the IP address when they log in. If an invalid port number (or no port number) is specified, the eco PDU will not be found.

Select whether to allow only secure browser logins, as show below:

### Service Ports

Only HTTPs  HTTP / HTTPs

HTTP:

HTTPs:

An explanation of the fields is given in the table below:

Field	Explanation
HTTP	The port number for a browser login. The default is 80.
HTTPS	The port number for a secure browser login. The default is 443.

- Note:**
1. Valid entries for all of the service ports are from 1 to 65535.
  2. The service ports cannot have the same value. You must set a different value for each one.
  3. If there is no firewall (on an Intranet, for example), it doesn't matter what these numbers are set to, since they have no effect.

## IPv4 Configuration

The PDU's IPv4 IP and DNS addresses (the traditional method of specifying IP addresses) can either be assigned dynamically (DHCP), or a fixed IP address can be specified.

### IPv4 Configuration

Obtain IP address automatically [DHCP]

Set IP address manually [Fixed IP]

IP Address:

Subnet Mask:

Default Gateway:

Obtain DNS server address automatically

Set DNS server address manually

Preferred DNS Server:

Alternate DNS Server:

- ◆ For dynamic IP address assignment, select the *Obtain IP address automatically* radio button. (This is the default setting.)
- ◆ To specify a fixed IP address, select the *Set IP address manually* radio button and fill in the IP address with values appropriate for your network.
- ◆ For automatic DNS Server address assignment, select the *Obtain DNS Server address automatically* radio button.
- ◆ To specify the DNS Server address manually, select the *Set DNS server address manually* radio button, and fill in the addresses for the Preferred and Alternate DNS servers with values appropriate for your network.

---

**Note:** 1. If you choose *Obtain IP address automatically*, when the device starts up it waits to get its IP address from the DHCP server. If it hasn't obtained the address after one minute, it automatically reverts to its factory default IP address (192.168.0.60.)

2. If the device is on a network that uses DHCP to assign network addresses, and you need to ascertain its IP address, see *IP Address Determination*, page 73, for information.

3. Specifying the Alternate DNS Server address is optional.

---

## Event Notification

The Event Notification section is divided into three sections: SMTP Settings; SNMP Trap Receivers; and Syslog Server. Each section is described below.

### ◆ SMTP Settings

#### Event Notification

##### SMTP Server

Enable report from the following SMTP Server

SMTP Server:

My server requires authentication

Account Name:

Password:

From:

To:

To have the eco PDU device email reports from the SMTP server to you, do the following:

1. Enable the *Enable report from the following SMTP server*, and key in the IP address of your SMTP server.
2. If your server requires authentication, put a check in the *My server requires authentication* checkbox.
3. Key in the appropriate account information in the *Account Name*, *Password*, and *From* fields.

---

**Note:** Only one email address is allowed in the *From* fields, and it cannot exceed 64 characters.)

---

4. Key in the email address (addresses) of where you want the event reports sent to in the *To* field.

---

**Note:** If you are sending the report to more than one email address, separate the addresses with a semicolon. The total cannot exceed 256 characters.

---

## ◆ SNMP Trap Receivers

### SNMP Trap Receiver

<input type="checkbox"/> Enable SNMP Trap	<input checked="" type="radio"/> SNMPv3	<input type="radio"/> SNMPv2c	<input type="radio"/> SNMPv1
Receiver IP 1:	<input type="text" value="0.0.0.0"/>		
Service Port 1:	<input type="text" value="162"/>		
Community 1:	<input type="text"/>		
User name 1:	<input type="text"/>		
Auth-password 1:	<input type="text"/>		
Priv-Password 1:	<input type="text"/>		
Receiver IP 2:	<input type="text" value="0.0.0.0"/>		
Service Port 2:	<input type="text" value="162"/>		
Community 2:	<input type="text"/>		
User name 2:	<input type="text"/>		
Auth-password 2:	<input type="text"/>		
Priv-Password 2:	<input type="text"/>		

Up to four SNMP management stations can be specified. If you want to use SNMP trap notifications, do the following:

1. Check *Enable SNMP Trap*.
2. Select which version of SNMP you want to use.
3. Key in the IP address(es) and the service port number(s) of the computer(s) to be notified of SNMP trap events. The valid port range is 1–65535. The default port number is 162.

---

**Note:** Make sure that the port number you specify here matches the port number used by the SNMP receiver computer.

---

4. Key in the community value(s) if required for the SNMP version.
5. Key in the auth/privacy password(s) that correspond to each of the stations.

---

## Syslog Server

### Syslog Server

Enable Syslog Server

Server IP:

Service Port:

To record all the events that take place on eco PDU devices and write them to the eco PDU Syslog server, do the following:

1. Check **Enable Syslog Server**.
2. Key in the IP address and the port number of the Syslog server. The valid port range is 1–65535. The default port number is 514.

## Date/Time

The Date/Time dialog page sets the eco PDU time parameters:

### Date Time

#### Time Zone

(GMT-12:00) Eniwetok Kwajalein ▼

Daylight Savings Time

#### Manual Input

Date:    
(YYYY-MM-DD)

Time:  (HH:MM:SS)

Sync with PC

#### Network Time

Enable auto adjustment

AU | ntp1.cs.mu.OZ.AU ▼

Preferred custom server IP:

Alternate time server:

AU | ntp1.cs.mu.OZ.AU ▼

Alternate custom server IP:

Adjust time everyday

Adjust Time Now

### Time Zone

- ◆ To establish the time zone that the eco PDU is located in, drop down the *Time Zone* list and choose the city that most closely corresponds to where it is at.
- ◆ If your country or region employs daylight saving time (summer time), check the corresponding checkbox.

## Manual Input

Use this section to specify the eco PDU's date and time manually.

- ◆ Click the calendar icon and click the calendar entry for the date.
- ◆ Key the time into the Time field, using the HH:MM:SS (hours, minutes, seconds) format.

---

**Note:** This section is only enabled when *auto adjustment* (in the *Network Time* section) is disabled (the checkbox is unchecked).

---

As an alternative to specifying the date and time by entering them into the date and time fields, you can click to put a check in the *Sync with PC* checkbox, in which case the eco PDU will take its date and time settings from the locally connected PC.

## Network Time

To have the time automatically synchronized to a network time server, do the following:

1. Check the *Enable auto adjustment* checkbox.
2. Drop down the time server list to select your preferred time server  
– or –

Check the *Preferred custom server IP* checkbox, and key in the IP address of the time server of your choice.

3. If you want to configure an alternate time server, check the *Alternate time server* checkbox, and repeat step 2 for the alternate time server entries.
4. Key in your choice for the number of days between synchronization procedures.

## Finishing Up

When you have finished making your settings on this page, click **Save**.

After you have saved your changes, if you want to synchronize immediately, click **Adjust Time Now**.

## **Security**

The *Security* page controls access to the eco PDU device.

**Security**

**Login Failures**

Allowed:

Timeout:  min

**Working Mode**

Enable ICMP

### **Login Failures**

- ◆ **Allowed** sets the number of consecutive failed login attempts that are permitted from a remote user.
- ◆ **Timeout** sets the amount of time a remote user must wait before attempting to login again after exceeding the number of allowed failures.

### **Working Mode**

- ◆ If *ICMP* is **enabled**, the eco PDU device can be pinged. If it is not enabled, the device cannot be pinged. The default is enabled.

When you have finished making your settings on this page, click **Save**.



## Account Policy

The Account Policy section governs policies in regard to usernames and passwords.

### Account Policy

Minimum Username Length:

Minimum Password Length:

Password Must Contain At Least:

- One Upper Case
- One Lower Case
- One Number

Disable Duplicate Login

Check a policy and enter the required information in the appropriate fields.

Item	Description
Minimum Username Length	Sets the minimum number of characters required for a username. Acceptable values are from 1 to 16.
Minimum Password Length	Sets the minimum number of characters required for a password. Acceptable values are from 1 to 16.
Password Must Contain At Least	Checking any of these items requires users to include at least one of the specified items in their password. <b>Note:</b> This policy does not affect existing user accounts. Only new user accounts created after this policy has been enabled, and users required to change their passwords are affected.
Disable Duplicate Login	Check this to prevent users from logging in with the same account at the same time.

## Login String / IP Filter / Mac Filter

### Login String/IP Filter/MAC Filter

Login String:

IP Filter Enable       Include       Exclude

MAC Filter Enable       Include       Exclude

### ■ Login String

The *Login String* entry field is used to specify a login string (in addition to the IP address) that users must include when accessing the eco PDU device with a browser. For example:

192.168.0.126/abcdefg

- ◆ The following characters are allowed:

0–9 a–z A–Z ~ ! @ \$ \* ( ) \_ ' ,

- ◆ The following characters are not allowed:

& ^ { } ' ' < > | " % " : / ? # \ [Space] + - = [ ] ;

Compound characters (É Ç ñ ... etc.)

---

**Note:** 1. There must be a forward slash between the IP address and the string.

2. If no login string is specified here, anyone will be able to access the eco PDU device login page using the IP address alone. This makes your installation less secure.
- 

For security purposes, we recommend that you change this string occasionally.

---

## ■ IP Filter / MAC Filter

If any filters have been configured, they appear in the IP Filter and/or MAC Filter list boxes.

IP and MAC Filters control access to the eco PDU based on the IP and/or MAC addresses of the client computers attempting to connect. A maximum of 5 IP filters and 5 MAC filters are allowed.

To enable IP and/or MAC filtering, click to put a check mark in the *IP Filter Enable* and/or *MAC Filter Enable* checkbox.

- ◆ If the include button is checked, all the addresses within the filter range are allowed access; all other addresses are denied access.
- ◆ If the exclude button is checked, all the addresses within the filter range are denied access; all other addresses are allowed access.

### Adding Filters

To add an IP filter, do the following:

1. Click **Add**. A dialog box similar to the one below appears:

**Enter the start IP address (for example, 192.168.0.1):**

**Enter the end IP address (for example, 192.168.1.255):**

OK Cancel

2. Specify the start filter address in the dialog box (for example, 192.168.0.200), then click **OK**.
3. To filter a single IP address, key in the same address as the start IP. To filter a continuous range of addresses, key in the end number of the range (for example, 192.168.0.225).
4. After filling in the address, click **OK**.

Repeat these steps for any additional IP addresses you want to filter.

To add a MAC filter, do the following:

1. Click **Add**. A dialog box similar to the one below appears:

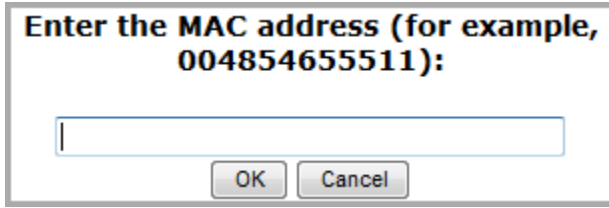

2. Specify the MAC address in the dialog box (for example, 001074670000), then click **OK**.

Repeat these steps for any additional MAC addresses you want to filter.

### **IP Filter / MAC Filter Conflict**

If there is a conflict between an IP filter and a MAC filter – for example, where a computer’s IP address is allowed by the IP filter but its MAC address is excluded by the MAC filter – then that computer’s access is blocked.

In other words, if either filter blocks a computer, then the computer is blocked, no matter what the other filter is set to.

### **Modifying Filters**

To modify a filter, select it in the IP Filter or MAC Filter list box and click **Modify**. The Modify dialog box is similar to the Add dialog box. When it comes up, simply delete the old address(es) and replace it with the new one(s).

### **Deleting Filters**

To delete a filter, select it in the IP Filter or MAC Filter list box and click **Delete**.

## Authentication & Authorization

The Authentication & Authorization page is used to set up login authentication and authorization management from external sources.

### Authentication & Authorization

#### RADIUS Settings

Enable RADIUS

Preferred RADIUS Server IP:	<input type="text" value="0.0.0.0"/>
Preferred RADIUS Service Port:	<input type="text" value="1812"/>
Alternate RADIUS Server IP:	<input type="text" value="0.0.0.0"/>
Alternate RADIUS Server Port:	<input type="text" value="1645"/>
Timeout:	<input type="text" value="1"/> sec
Retries:	<input type="text" value="0"/>
Shared Secret (at least 6 characters):	<input type="text"/>

### RADIUS Settings

To allow authentication and authorization for the eco PDU device through a RADIUS server, do the following:

1. Check **Enable**.
2. Fill in the IP addresses and service port numbers for the Preferred and Alternate RADIUS servers. The default port number for the Preferred server is 1812; the default port number for the Alternate server is 1645.

---

**Note:** Make sure that the port numbers you specify here match the port numbers used by the RADIUS servers.

---

3. In the *Timeout* field, set the time in seconds that the eco PDU device waits for a RADIUS server reply before it times out.
4. In the *Retries* field, set the number of allowed retries for attempting to connect to the RADIUS server.
5. In the *Shared Secret* field, key in the character string that you want to use for authentication between the eco PDU device and the RADIUS Server.

6. On the RADIUS server, set the entry for each user as follows:

```
su/administrator or su/user
```

Where *user* represents the username given to the user when the account was created on the eco PDU device. The user's access rights are the ones assigned for the eco PDU device, as well. (See *User Information*, page 41.)

---

**Note:** su/user supports view ports only; su/administrator supports all eco PDU functions.

---

## **Private Certificate**

When logging in over a secure (SSL) connection, a signed certificate is used to verify that the user is logging in to the intended site. For enhanced security, the *Private Certificate* section allows you to use your own private encryption key and signed certificate, rather than the default ATEN certificate.

### **Private Certificate**

Private Key:	<input type="text"/>	<input type="button" value="Browse..."/>	
Certificate:	<input type="text"/>	<input type="button" value="Browse..."/>	
		<input type="button" value="Upload"/>	<input type="button" value="Restore default"/>

There are two methods for establishing your private certificate: generating a self-signed certificate; and importing a third-party certificate authority (CA) signed certificate.

### **Generating a Self-Signed Certificate**

If you wish to create your own self-signed certificate, a free utility—`openssl.exe`—is available for download over the web.

### **Obtaining a CA Signed SSL Server Certificate**

For the greatest security, we recommend using a third party certificate authority (CA) signed certificate. To obtain a third party signed certificate, go to a CA (Certificate Authority) website to apply for an SSL certificate. After the CA sends you the certificate and private encryption key, save them to a convenient location on your computer.

*(Continues on next page.)*

### Importing the Private Certificate

To import the private certificate, do the following:

1. Click **Browse** to the right of *Private Key*; browse to where your private encryption key file is located; and select it.
2. Click **Browse** to the right of *Certificate*; browse to where your certificate file is located; and select it.
3. Click **Upload** to complete the procedure.

---

**Note:** 1. Clicking **Restore Default** returns the device to using the default ATEN certificate.

2. Both the private encryption key and the signed certificate must be imported at the same time.
- 

When you have finished making your settings on this page, click **Save**.

## PDU

The *PDU* tab is used to upgrade the eco PDU's firmware, and to backup and restore the device's configuration settings.

### Firmware File

When you click the **Maintenance** tab, the display opens with the *Firmware Upgrade* menu page, which looks similar to the one below:

**Firmware File**

Check Main Firmware Version

Energy Box Name	F/W Version
[PE1108A]	F/W Ver:1.1.133

Filename:

**Backup**

Password:

**Restore**

Filename:

Password:

A description of the items shown in this panel are given in the table, below:

Item	Description
Check Main Firmware Version	If you enable <i>Check Main Firmware Version</i> , the eco PDU's current firmware level is compared with that of the upgrade file. If the current version is equal to or higher than the upgrade version, a popup message appears, to inform you of the situation and stops the upgrade procedure.
Name	Lists all of the eco PDU devices. Click to put a check in the checkbox of the device's whose firmware you want to upgrade.
F/W Version	Displays the eco PDU's current firmware version.
Filename	As new versions of the firmware become available, they are posted on our website and can be downloaded to a convenient location on your computer. Click the <i>Browse</i> button to select the downloaded upgrade file.
Upgrade	Click this button to upgrade the firmware of the selected devices.



### ■ Upgrading the Firmware

To upgrade the firmware refer to the screenshot on the preceding page, and do the following:

1. Go to our website and download the new firmware file to a convenient location on your computer.
2. Click the *Browse* button; navigate to where the firmware file is located and select it.
3. Click **Upgrade** to start the upgrade procedure.
  - ◆ If you enabled *Check Main Firmware Version* the current firmware level is compared with that of the upgrade file. If the current version is equal to or higher than the upgrade version, a popup message appears, to inform you of the situation and stops the upgrade procedure.
  - ◆ If you didn't enable *Check Main Firmware Version*, the upgrade file is installed without checking what its level is.
  - ◆ Once the upgrade completes successfully, the PDU resets itself.
4. Log in again, and check the firmware version to be sure it is the new one.

### ■ Firmware Upgrade Recovery

Should the eco PDU's firmware upgrade procedure fail, and the device becomes unusable, the following firmware upgrade recovery procedure will resolve the problem:

1. Power off the device.
2. Press and hold the reset button (see page 9).
3. While holding the reset button, power the PDU back on.

This causes the unit to use the original factory installed main firmware version. Once the switch is operational, you can try upgrading the main firmware again.

## **Backup/Restore**

Selecting *Backup/Restore* on the menu bar gives you the ability to back up the switch's configuration and user profile information:

### **Backup**

To backup the device's settings do the following:

1. In the *Password* field, key in a password for the file.

---

**Note:** Entering a password is optional. If you do enter a password, make a note of it, since you will need it to be able to restore the file.

---

2. Click **Save**.
3. When the browser asks what you want to do with the file, select *Save to disk*; then save it in a convenient location.

### **Restore**

To restore a previous backup, do the following:

1. Click **Browse**; navigate to the file and select it.

---

**Note:** If you renamed the file, you can leave the new name. There is no need to return it to its original name.

---

2. In the *Password* field, key in the same password that you used to save the file.

---

**Note:** If you did not set a password when you created the backup file, you can omit this step.

---

3. Select as many of the options that are presented as you wish to restore.
4. Click **Restore**.

After the file is restored, a message appears to inform you that the procedure succeeded.

## Safety Instructions

---

### General

- ◆ This product is for indoor use only.
- ◆ Read all of these instructions. Save them for future reference.
- ◆ Follow all warnings and instructions marked on the device.
- ◆ Do not place the device on any unstable surface (cart, stand, table, etc.). If the device falls, serious damage will result.
- ◆ Do not use the device near water.
- ◆ Do not place the device near, or over, radiators or heat registers.
- ◆ The device cabinet is provided with slots and openings to allow for adequate ventilation. To ensure reliable operation, and to protect against overheating, these openings must never be blocked or covered.
- ◆ The device should never be placed on a soft surface (bed, sofa, rug, etc.) as this will block its ventilation openings. Likewise, the device should not be placed in a built in enclosure unless adequate ventilation has been provided.
- ◆ Never spill liquid of any kind on the device.
- ◆ Unplug the device from the wall outlet before cleaning. Do not use liquid or aerosol cleaners. Use a damp cloth for cleaning.
- ◆ The device should be operated from the type of power source indicated on the marking label. If you are not sure of the type of power available, consult your dealer or local power company.
- ◆ To prevent damage to your installation it is important that all devices are properly grounded.
- ◆ The device is designed for IT power distribution systems with 100V to 230V phase-to-phase voltage.
- ◆ The device is equipped with a 3-wire grounding type plug. This is a safety feature. If you are unable to insert the plug into the outlet, contact your electrician to replace your obsolete outlet. Do not attempt to defeat the purpose of the grounding-type plug. Always follow your local/national wiring codes.

- ◆ If an extension cord is used with this device make sure that the total of the ampere ratings of all products used on this cord does not exceed the extension cord ampere rating. Make sure that the total of all products plugged into the wall outlet does not exceed 15 amperes.
- ◆ The equipment should be installed near the wall socket outlet and the disconnect device (appliance coupler) should be readily accessible.
- ◆ Do not allow anything to rest on the power cord or cables. Route the power cord and cables so that they cannot be stepped on or tripped over.
- ◆ To help protect your system from sudden, transient increases and decreases in electrical power, use a surge suppressor, line conditioner, or uninterruptible power supply (UPS).
- ◆ Position system cables and power cables carefully; Be sure that nothing rests on any cables.
- ◆ When connecting or disconnecting power to hot pluggable power supplies, observe the following guidelines:
  - ◆ Install the power supply before connecting the power cable to the power supply.
  - ◆ Unplug the power cable before removing the power supply.
  - ◆ If the system has multiple sources of power, disconnect power from the system by unplugging all power cables from the power supplies.
- ◆ Never push objects of any kind into or through cabinet slots. They may touch dangerous voltage points or short out parts resulting in a risk of fire or electrical shock.
- ◆ Do not attempt to service the device yourself. Refer all servicing to qualified service personnel.
- ◆ If the following conditions occur, unplug the device from the wall outlet and bring it to qualified service personnel for repair.
  - ◆ The power cord or plug has become damaged or frayed.
  - ◆ Liquid has been spilled into the device.
  - ◆ The device has been exposed to rain or water.
  - ◆ The device has been dropped, or the cabinet has been damaged.
  - ◆ The device exhibits a distinct change in performance, indicating a need for service.
  - ◆ The device does not operate normally when the operating instructions are followed.

- ◆ Only adjust those controls that are covered in the operating instructions. Improper adjustment of other controls may result in damage that will require extensive work by a qualified technician to repair.
- ◆ Do not connect the RJ-11 connector marked “Sensor” to a public telecommunication network.

## Consignes de sécurité

---

### Général

- ♦ Ce produit est destiné exclusivement à une utilisation à l'intérieur.
- ♦ Veuillez lire la totalité de ces instructions. Conservez-les afin de pouvoir vous y référer ultérieurement.
- ♦ Respectez l'ensemble des avertissements et instructions inscrits sur l'appareil.
- ♦ Ne placez jamais l'unité sur une surface instable (chariot, pied, table, etc.). Si l'unité venait à tomber, elle serait gravement endommagée.
- ♦ N'utilisez pas l'unité à proximité de l'eau.
- ♦ Ne placez pas l'unité à proximité de ou sur des radiateurs ou bouches de chaleur.
- ♦ Le boîtier de l'unité est doté de fentes et d'ouvertures destinées à assurer une ventilation adéquate. Pour garantir un fonctionnement fiable et protéger l'unité contre les surchauffes, ces ouvertures ne doivent jamais être bloquées ou couvertes.
- ♦ L'unité ne doit jamais être placée sur une surface molle (lit, canapé, tapis, etc.) car ses ouvertures de ventilation se trouveraient bloquées. De même, l'unité ne doit pas être placée dans un meuble fermé à moins qu'une ventilation adaptée ne soit assurée.
- ♦ Ne renversez jamais de liquides de quelque sorte que ce soit sur l'unité.
- ♦ Débranchez l'unité de la prise murale avant de la nettoyer. N'utilisez pas de produits de nettoyage liquide ou sous forme d'aérosol. Utilisez un chiffon humide pour le nettoyage de l'unité.
- ♦ L'appareil doit être alimenté par le type de source indiqué sur l'étiquette. Si vous n'êtes pas sûr du type d'alimentation disponible, consultez votre revendeur ou le fournisseur local d'électricité.
- ♦ Afin de ne pas endommager votre installation, vérifiez que tous les périphériques sont correctement mis à la terre.
- ♦ L'unité est équipée d'une fiche de terre à trois fils. Il s'agit d'une fonction de sécurité. Si vous ne parvenez pas à insérer la fiche dans la prise murale, contactez votre électricité afin qu'il remplace cette dernière qui doit être obsolète. N'essayez pas d'aller à l'encontre de l'objectif de la fiche de terre. Respectez toujours les codes de câblage en vigueur dans votre région/pays.

- 
- ◆ L'équipement doit être installé à proximité de la prise murale et le dispositif de déconnexion (prise de courant femelle) doit être facile d'accès.
  - ◆ Veillez à ce que rien ne repose sur le cordon d'alimentation ou les câbles. Acheminez le cordon d'alimentation et les câbles de sorte que personne ne puisse marcher ou trébucher dessus.
  - ◆ Pour contribuer à protéger votre système contre les augmentations et diminutions soudaines et transitoires de puissance électrique, utilisez un parasurtenseur, un filtre de ligne ou un système d'alimentation sans coupure (UPS).
  - ◆ Placez les câbles du système et les câbles d'alimentation avec précaution; veillez à ce que rien ne repose sur aucun des câbles.
  - ◆ Lors du branchement ou du débranchement à des blocs d'alimentation permettant la connexion à chaud, veuillez respecter les lignes directrices suivantes:
    - ◆ Installez le bloc d'alimentation avant de brancher le câble d'alimentation à celui-ci.
    - ◆ Débranchez le câble d'alimentation avant de retirer le bloc d'alimentation.
    - ◆ Si le système présente plusieurs sources d'alimentation, déconnectez le système de l'alimentation en débranchant tous les câbles d'alimentation des blocs d'alimentation.
  - ◆ N'insérez jamais d'objets de quelque sorte que ce soit dans ou à travers les fentes du boîtier. Ils pourraient entrer en contact avec des points de tension dangereuse ou court-circuiter des pièces, entraînant ainsi un risque d'incendie ou de choc électrique.
  - ◆ N'essayez pas de réparer l'unité vous-même. Confiez toute opération de réparation à du personnel qualifié.
  - ◆ Si les conditions suivantes se produisent, débranchez l'unité de la prise murale et amenez-la à un technicien qualifié pour la faire réparer.
    - ◆ Le cordon d'alimentation ou la fiche ont été endommagés ou éraillés.
    - ◆ Du liquide a été renversé dans l'unité.
    - ◆ L'unité a été exposée à la pluie ou à l'eau.
    - ◆ L'unité est tombée ou le boîtier a été endommagé.
    - ◆ Les performances de l'unité sont visiblement altérées, ce qui indique la nécessité d'une réparation.
    - ◆ L'unité ne fonctionne pas normalement bien que les instructions d'utilisation soient respectées.
-

- ♦ N'utilisez que les commandes qui sont abordées dans le mode d'emploi. Le réglage incorrect d'autres commandes peut être à l'origine de dommages qui nécessiteront beaucoup de travail pour qu'un technicien qualifié puisse réparer l'unité.
- ♦ Ne connectez pas le connecteur RJ-11 portant la marque « Sensor » (Capteur) à un réseau de télécommunication public.



---

## **Rack Mounting**

- ◆ Before working on the rack, make sure that the stabilizers are secured to the rack, extended to the floor, and that the full weight of the rack rests on the floor. Install front and side stabilizers on a single rack or front stabilizers for joined multiple racks before working on the rack.
- ◆ Always load the rack from the bottom up, and load the heaviest item in the rack first.
- ◆ Make sure that the rack is level and stable before extending a device from the rack.
- ◆ Use caution when pressing the device rail release latches and sliding a device into or out of a rack; the slide rails can pinch your fingers.
- ◆ After a device is inserted into the rack, carefully extend the rail into a locking position, and then slide the device into the rack.
- ◆ Do not overload the AC supply branch circuit that provides power to the rack. The total rack load should not exceed 80 percent of the branch circuit rating.
- ◆ Make sure that all equipment used on the rack – including power strips and other electrical connectors – is properly grounded.
- ◆ Ensure that proper airflow is provided to devices in the rack.
- ◆ Ensure that the operating ambient temperature of the rack environment does not exceed the maximum ambient temperature specified for the equipment by the manufacturer
- ◆ Do not step on or stand on any device when servicing other devices in a rack.

## **The eco PDU's Main Power Cord**

Use the power cord supplied with this package. If it becomes necessary to replace the cord supplied with this package, be sure to use a cord of at least the same standard as the one provided.

## **Securing the Power Cables**

 To secure the cables in the eco PDU's power outlets, use only the ATEN Lok-U-Plug cable holders that have been specifically designed to work with the eco PDU. Using any other kind of cable securing device could be highly dangerous. Please contact your ATEN dealer for information about ATEN Lok-U-Plugs.

## **Montage sur bâti**

- ◆ Avant de travailler sur le bâti, assurez-vous que les stabilisateurs sont bien fixés sur le bâti, qu'ils sont étendus au sol et que tout le poids du bâti repose sur le sol. Installez les stabilisateurs avant et latéraux sur un même bâti ou bien les stabilisateurs avant si plusieurs bâtis sont réunis, avant de travailler sur le bâti.
- ◆ Chargez toujours le bâti de bas en haut et chargez l'élément le plus lourd en premier.
- ◆ Assurez-vous que le bâti est à niveau et qu'il est stable avant de sortir une unité du bâti.
- ◆ Agissez avec précaution lorsque vous appuyez sur les loquets de libération du rail d'unité et lorsque vous faites coulisser une unité dans et hors d'un bâti ; vous pourriez vous pincer les doigts dans les rails.
- ◆ Une fois qu'une unité a été insérée dans le bâti, étendez avec précaution le rail dans une position de verrouillage puis faites glisser l'unité dans le bâti.
- ◆ Ne surchargez pas le circuit de l'alimentation CA qui alimente le bâti. La charge totale du bâti ne doit pas dépasser 80 % de la capacité du circuit.
- ◆ Assurez-vous que tous les équipements utilisés sur le bâti, y-compris les multiprises et autres connecteurs électriques, sont correctement mis à la terre.
- ◆ Assurez-vous que les unités présentes dans le bâti bénéficie d'une circulation d'air suffisante.
- ◆ Assurez-vous que la température ambiante de fonctionnement de l'environnement du bâti ne dépasse pas la température ambiante maximale spécifiée pour l'équipement par le fabricant.
- ◆ Ne marchez sur aucun appareil lors de la maintenance d'autres appareils d'un bâti.

## **Le cordon d'alimentation principale de l'unité d'alimentation éco**

Utilisez le câble d'alimentation fourni. Au cas où il s'avèrerait nécessaire de remplacer le cordon fourni avec l'appareil, veillez à utiliser un cordon respectant au minimum la même norme que celui d'origine.



### **Fixation des câbles d'alimentation**

Pour fixer les câbles aux sorties d'alimentation de l'unité d'alimentation éco, utilisez uniquement les supports de câble Lok-U-Plug d'ATEN qui ont été conçus spécialement pour être utilisés avec l'unité

d'alimentation éco. L'utilisation de tout autre type système de fixation de câble pourrait s'avérer très dangereuse. Veuillez contacter votre revendeur ATEN pour plus d'informations sur le support de câble ATEN Lok-U-Plug.

## Technical Support

---

### International

- ◆ For online technical support – including troubleshooting, documentation, and software updates: **<http://eservice.aten.com>**
- ◆ For telephone support, see *Telephone Support*, page v

### North America

Email Support		<a href="mailto:support@aten-usa.com">support@aten-usa.com</a>
Online Technical Support	Troubleshooting Documentation Software Updates	<a href="http://www.aten-usa.com/support">http://www.aten-usa.com/support</a>
Telephone Support		1-888-999-ATEN ext 4988 1-949-428-1111

When you contact us, please have the following information ready beforehand:

- ◆ Product model number, serial number, and date of purchase.
- ◆ Your computer configuration, including operating system, revision level, expansion cards, and software.
- ◆ Any error messages displayed at the time the error occurred.
- ◆ The sequence of operations that led up to the error.
- ◆ Any other information you feel may be of help.

## IP Address Determination

If you are an administrator logging in for the first time, you need to access the eco PDU in order to give it an IP address that users can connect to. There are two methods to choose from. In each case, your client computer must be on the same network segment as the eco PDU. After you have connected and logged in you can give the device its fixed network address. (See *Notification Settings*, page 43.)

### Method 1:

For computers running Windows, an IP address can be determined and/or assigned with the IP Installer utility. The utility can be obtained from the *Download* area of our website. Look under *Driver/SW*, and the model of your device. After downloading the utility to your computer, do the following:

1. Unzip the contents of *IPInstaller.zip* to a directory on your hard drive.
2. Go to the directory that you unzipped the IPInstaller program to and run *IPInstaller.exe*. A dialog box similar to the one below appears:

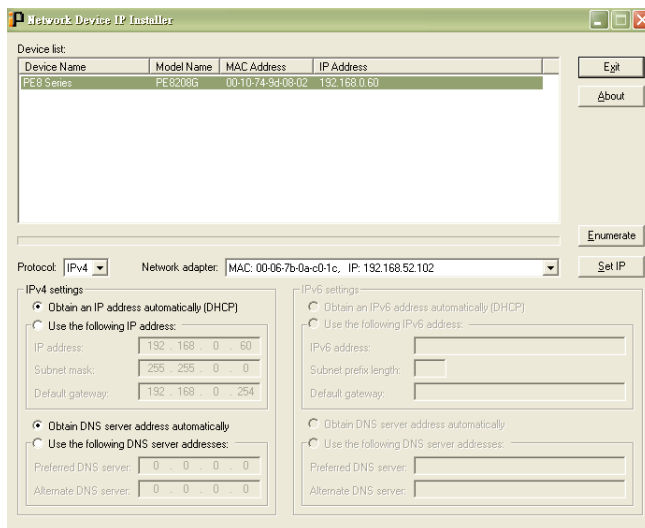

(Continues on next page.)

(Continued from previous page.)

3. Select the device in the *Device List*.

---

**Note:** 1. If the list is empty, or your device doesn't appear, click **Enumerate** to refresh the Device List.

2. If there is more than one device in the list, use the MAC address to pick the one you want. The eco PDU's MAC address is located on its bottom panel.
- 

4. Select either *Obtain an IP address automatically (DHCP)*, or *Specify an IP address*. If you chose the latter, fill the IP Address, Subnet Mask, and Gateway fields with the information appropriate to your network.
5. Click **Set IP**.
6. After the IP address shows up in the Device List, click **Exit** to end the program.

### **Method 2:**

1. Set your computer's IP address to 192.168.0.XXX  
Where XXX represents any number or numbers except 60. (192.168.0.60) is the default address of the eco PDU.)
2. Specify the device's default IP address (192.168.0.60) in your browser, and you will be able to connect.
3. Assign a fixed IP address for the device (see *IPv4 Configuration*, page 46), that is suitable for the network segment that it resides on.
4. After you log out, reset your computer's IP address to its original value.
5. Once you have logged in, go to Network Settings to set up the permanent IP environment (see *IPv4 Configuration*, page 46).

### **Method 3:**

ATEN eco DC allows you to determine/assign an IP address in order to configure a PDU device and monitor power status of the equipment connected to it. ATEN eco DC can be obtained from the Download area of the ATEN website.

# Specifications

## PE5108A / PE5208A / PE7108A / PE7208A

Function		PE5108A / PE7108A	PE5208A / PE7208A	
Power Outlets	Direct	8		
Connectors	Power Inlet	1 x IEC 320 C20		
	Power Outlets	NEMA	8 x NEMA 5-15R	
		IEC	8 x NEMA 5-20R	
	Sensor	NA		
LAN	2 x RJ-11			
LEDs	LAN	1 x RJ-45 (F)		
	Outlet Status	N/A		
	Selection	1-digit 7-segment (Orange)		
	PDU Current / Outlet Current / IP Address	3 (Green)		
	Current / IP Address	3-digit 7-segment (Orange)		
	Power	1 (Blue)		
	LAN	10/100M	1 (Orange / Green)	
		Link	1 (Green)	
Sensor	2 (Green)			
Switches	Reset	1 x Semi-recessed Pushbutton		
	Power	1 x Non-fuse Breaker		
I/P Rating		100–120V~; 50/60Hz; 12A	100–120V~; 50/60Hz; 16A	
Load Capacity		1440W	1920W	
O/P Rating	Per Port	100–120V~; 50/60Hz; 12A	100–120V~; 50/60Hz; 16A	
	Total	100–120V~; 50/60Hz; 12A	100–120V~; 50/60Hz; 16A	
Environment	Operating Temperature	0–50°C		
	Storage Temperature	-20–60°C		
	Humidity	0–80% RH Non-condensing		
Physical Properties	Housing	Metal		
	Weight	2.63 kg / 2.68 kg	2.64 kg / 2.69 kg	
	Dimensions (L x W x H)	43.24 x 21.93 x 4.40 cm		

**PE5108B / PE5208B / PE7108B / PE7208B**

Function			PE5108B / PE7108B	PE5208B / PE7208B
Power Outlets	Direct		8	
Connectors	Power Inlet		1 x IEC 320 C20	
	Power Outlets	NEMA	N/A	
		IEC	8 x IEC 320 C13	7 x IEC 320 C13 (Ports 2–8); 1 x C19 (Port 1)
	Sensor		2 x RJ-11	
LAN		1 x RJ-45 (F)		
LEDs	Outlet Status		N/A	
	Selection		1-digit 7-segment (Orange)	
	PDU Current / Outlet Current / IP Address		3 (Green)	
	Current / IP Address		3-digit 7-segment (Orange)	
	Power		1 (Blue)	
	LAN	10/100M	1 (Orange / Green)	
		Link	1 (Green)	
	Sensor		2 (Green)	
Switches	Reset		1 x Semi-recessed Pushbutton	
	Power		1 x Non-fuse Breaker	
I/P Rating			100–240V~; 50/60Hz; 12A	100–240V~; 50/60Hz; 16A
Load Capacity			2880W	3840W
O/P Rating	Per Port	C13	100–240V~; 50/60Hz, 12A	
		C19	N/A	100–240V~; 50/60Hz, 16A
	Total		100–240V~; 50/60Hz, 12A	100–240V~; 50/60Hz, 16A
Environment	Operating Temperature		0–50°C	
	Storage Temperature		-20–60°C	
	Humidity		0–80% RH Non-condensing	
Physical Properties	Housing		Metal	
	Weight		2.70 kg / 2.73 kg	2.71 kg / 2.74 kg
	Dimensions (L x W x H)		43.24 x 21.93 x 4.40 cm	



**PE5108G / PE5208G / PE7108G / PE7208G**

Function			PE5108G / PE7108G	PE5208G / PE7208G
Power Outlets	Direct		8	
Connectors	Power Inlet		1 x IEC 320 C20	
	Power Outlets	NEMA	N/A	
		IEC	8 x IEC 320 C13	7 x IEC 320 C13 (Ports 2–8); 1 x C19 (Port 1)
	Sensor		2 x RJ-11	
	LAN		1 x RJ-45 (F)	
LEDs	Outlet Status		N/A	
	Selection		1-digit 7-segment (Orange)	
	PDU Current / Outlet Current / IP Address		3 (Green)	
	Current / IP Address		3-digit 7-segment (Orange)	
	Power		1 (Blue)	
	LAN	10/100M	1 (Orange / Green)	
		Link	1 (Green)	
	Sensor		2 (Green)	
	Switches	Reset		1 x Semi-recessed Pushbutton
Power		1 x Non-fuse Breaker		
I/P Rating			100–240V~; 50/60Hz; 10A	100–240V~; 50/60Hz; 16A
Load Capacity			2400W	3840W
O/P Rating	Per Port	C13	100–240V; 50/60Hz, 10A	
		C19	N/A	100–240V~; 50/60Hz, 16A
	Total		100–240V~; 50/60Hz, 10A	100–240V~; 50/60Hz, 16A
Environment	Operating Temperature		0–50°C	
	Storage Temperature		-20–60°C	
	Humidity		0–80% RH Non-condensing	
Physical Properties	Housing		Metal	
	Weight		2.70 kg / 2.72 kg	2.71 kg / 2.74 kg
	Dimensions (L x W x H)		43.24 x 21.93 x 4.40 cm	

**PE6108A / PE6208A / PE8108A / PE8208A**

Function		PE6108A / PE8108A	PE6208A / PE8208A	
Power Outlets	Direct	8		
Connectors	Power Inlet	1 x IEC 320 C20		
	Power Outlets	NEMA	8 x NEMA 5-15R	8 x NEMA 5-20R
		IEC	NA	
	Sensor	2 x RJ-11		
	LAN	1 x RJ-45 (F)		
LEDs	Outlet Status	8 (Orange)		
	Selection	1-digit 7-segment (Orange)		
	PDU Current / Outlet Current / IP Address	3 (Green)		
	Current / IP Address	3-digit 7-segment (Orange)		
	Power	1 (Blue)		
	LAN	10/100M	1 (Orange / Green)	
		Link	1 (Green)	
	Sensor	2 (Green)		
Switches	Reset	1 x Semi-recessed Pushbutton		
	Power	1 x Non-fuse Breaker		
I/P Rating		100–120V~; 50/60Hz; 12A	100–120V~; 50/60Hz; 16A	
Load Capacity		1440W	1920W	
O/P Rating	Per Port	100–120V~; 50/60Hz; 12A	100–120V~; 50/60Hz; 16A	
	Total	100–120V~; 50/60Hz; 12A	100–120V~; 50/60Hz; 16A	
Environment	Operating Temperature	0–50°C		
	Storage Temperature	-20–60°C		
	Humidity	0–80% RH Non-condensing		
Physical Properties	Housing	Metal		
	Weight	2.77 kg / 2.80 kg	2.77 kg / 2.82 kg	
	Dimensions (L x W x H)	43.24 x 21.93 x 4.40 cm		

**PE6108B / PE6208B / PE8108B / PE8208B**

Function			PE6108B / PE8108B	PE6208B/ PE8208B
Power Outlets	Direct		8	
Connectors	Power Inlet		1 x IEC 320 C20	
	Power Outlets	NEMA	NA	
		IEC	8 x IEC 320 C13	7 x IEC 320 C13 (Ports 2–8); 1 x C19 (Port 1)
	Sensor		2 x RJ-11	
	LAN		1 x RJ-45 (F)	
LEDs	Outlet Status		8 (Orange)	
	Selection		1-digit 7-segment (Orange)	
	PDU Current / Outlet Current / IP Address		3 (Green)	
	Current / IP Address		3-digit 7-segment (Orange)	
	Power		1 (Blue)	
	LAN	10/100M	1 (Orange / Green)	
		Link	1 (Green)	
	Sensor		2 (Green)	
Switches	Reset		1 x Semi-recessed Pushbutton	
	Power		1 x Non-fuse Breaker	
I/P Rating			100–240V~; 50/60Hz; 12A	100–240V~; 50/60Hz; 16A
Load Capacity			2880W	3840W
O/P Rating	Per Port	C13	100-240V; 50/60Hz, 12A	
		C19	NA	100-240V~; 50/60Hz, 16A
	Total		100-240V~; 50/60Hz, 12A	100-240V~; 50/60Hz, 16A
Environment	Operating Temp		0–50°C	
	Storage Temp.		-20–60°C	
	Humidity		0–80% RH Non-condensing	
Physical Properties	Housing		Metal	
	Weight		2.82 kg / 2.87 kg	2.79 kg / 2.87 kg
	Dimensions (L x W x H)		43.24 x 21.93 x 4.40 cm	

**PE6108G / PE6208G / PE8108G / PE8208G**

Function			PE6108G / PE8108G	PE6208G/ PE8208G
Power Outlets	Direct		8	
Connectors	Power Inlet		1 x IEC 320 C20	
	Power Outlets	NEMA	NA	
		IEC	8 x IEC 320 C13	7 x IEC 320 C13 (Ports 2-8); 1 x C19 (Port 1)
	Sensor		2 x RJ-11	
LAN		1 x RJ-45 (F)		
LEDs	Outlet Status		8 (Orange)	
	Selection		1-digit 7-segment (Orange)	
	PDU Current / Outlet Current / IP Address		3 (Green)	
	Current / IP Address		3-digit 7-segment (Orange)	
	Power		1 (Blue)	
	Link		1 (Green)	
	LAN		1 (Orange / Green)	
	Sensor		2 (Green)	
Switches	Reset		1 x Semi-recessed Pushbutton	
	Power		1 x Non-fuse Breaker	
I/P Rating			100-240V~; 50/60Hz; 10A	100-240V~; 50/60Hz; 16A
Load Capacity			2400W	3840W
O/P Rating	Per Port	C13	100-240V; 50/60Hz, 10A	
		C19	NA	100-240V~; 50/60Hz, 16A
	Total		100-240V~; 50/60Hz, 10A	100-240V~; 50/60Hz, 16A
Environment	Operating Temp.		0-50°C	
	Storage Temp.		-20-60°C	
	Humidity		0-80% RH Non-condensing	
Physical Properties	Housing		Metal	
	Weight		2.82 kg / 2.87 kg	2.79 kg / 2.87 kg
	Dimensions (L x W x H)		43.24 x 20.0 x 4.40 cm	

## Administrator Login Failure

If you are unable to perform an administrator login (because the username and password information has become corrupted, or you have forgotten it, for example), you can clear the login information with the following procedure:

1. Power off the eco PDU and remove its housing.
2. Short the jumper labeled J6 (PIN10 and PIN9).

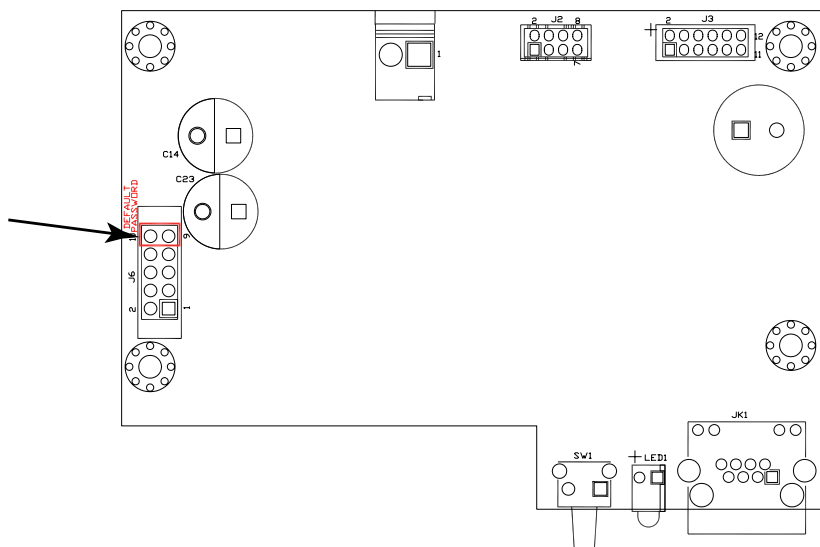

3. Power on the eco PDU.
4. When the 1-digit, 7-segment display shows “P”, power off the PDU.
5. Remove the jumper cap from J6.
6. Close the housing and start the eco PDU.  
After you start, you can use the default username and password to log in.

## **ATEN Standard Warranty Policy**

---

### **Limited Hardware Warranty**

ATEN warrants its hardware in the country of purchase against flaws in materials and workmanship for a Warranty Period of two [2] years (warranty period may vary in certain regions/countries) commencing on the date of original purchase. This warranty period includes the [LCD panel of ATEN LCD KVM switches](#). For UPS products, the device warranty is two [2] years but battery is one [1] year. Select products are warranted for an additional year (see [A+ Warranty](#) for further details). Cables and accessories are not covered by the Standard Warranty.

### **What is covered by the Limited Hardware Warranty**

ATEN will provide a repair service, without charge, during the Warranty Period. If a product is defective, ATEN will, at its discretion, have the option to (1) repair said product with new or repaired components, or (2) replace the entire product with an identical product or with a similar product which fulfills the same function as the defective product. Replaced products assume the warranty of the original product for the remaining period or a period of 90 days, whichever is longer. When the products or components are replaced, the replacing articles shall become customer property and the replaced articles shall become the property of ATEN.

To learn more about our warranty policies, please visit our website:

<http://www.aten.com/global/en/legal/policies/warranty-policy/>

Copyright © 2023 ATEN® International Co., Ltd.  
Released: 2023-08-10

ATEN and the ATEN logo are registered trademarks of ATEN International Co., Ltd. All rights reserved. All other brand names and trademarks are the registered property of their respective owners.