



Datenblatt - Fiche technique - Data sheet

11.99.5797



VALUE Mini DisplayPort Kabel, Mini DP-UHDTV, ST/ST, schwarz, 3,0 m

VALUE Mini DisplayPort Câble, Mini DP - UHDTV, M/M, noir, 3,0 m

VALUE Mini DisplayPort Cable, Mini DP-UHDTV, M/M, black, 3.0 m

RoHS Compliant

P1

HDMI MALE

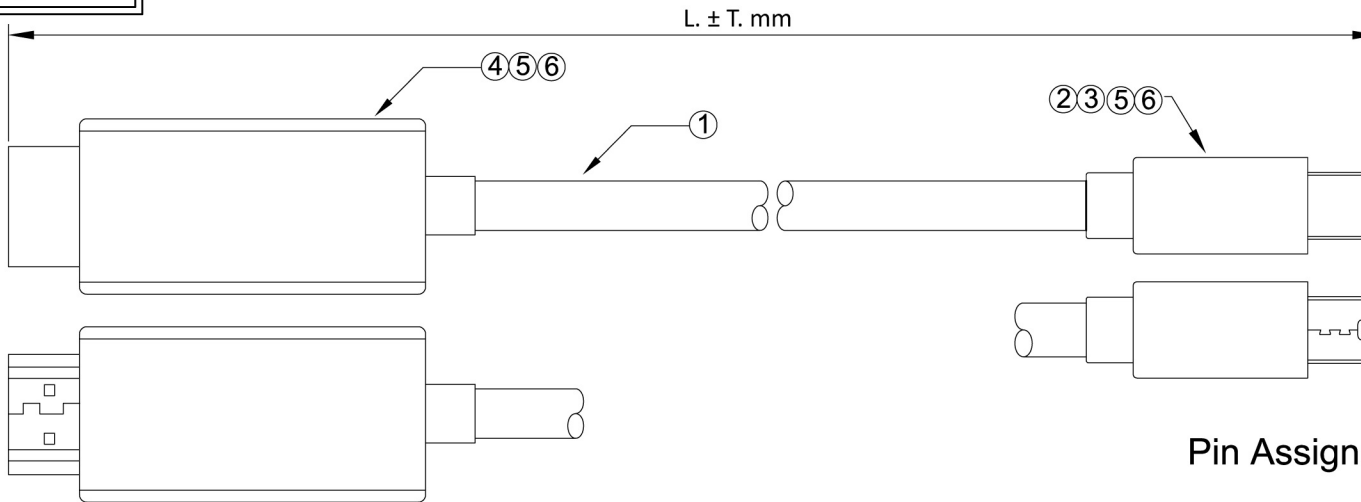
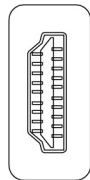

MINI DISPLAYPORT PLUG

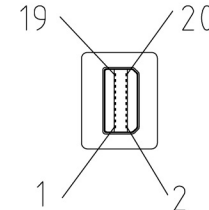

P2

Pin Assignment

Table :

P/N	Length
11.99.5795	1000 ± 20 mm
11.99.5796	2000 ± 30 mm
11.99.5797	3000 ± 40 mm

Test requirement:
Resolution:4K*2K@60HZ

- 1 Cable [30AWG(7/0.1T)x1P+D+AL+MYLAR]x5P+30AWG(7/0.1T)x5C+F+ADB16/5/0.12(AL) ◦
Jacket : PVC, Black ◦ O.D.=6.0±0.20mm ◦
- 2 Mini DP Connector Male, Solder, Nickel Plated
- 3 Shell Mini DP : ABS, Black
- 4 HDMI Connector Mini DP to HDMI PCB'A, Nickel Plated
Shell : ABS, Black
- 5 PE LDPE
- 6 PVC 60P, Black

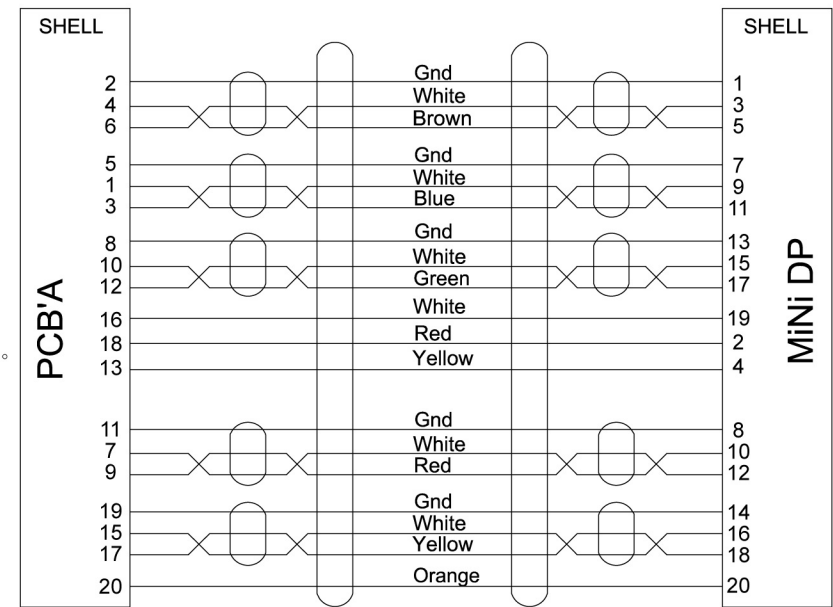

REV.	DATE	CONTENTS OF CHANGE	DESIGNER	TOL ±								APPROVAL	CHECK	DRAWING	DESIGN	DRAWING NAME	VALUE Mini DisplayPort Cable, MiniDP-UHDTV, M/M		
				RANGE	Pla	Met	Ins	Por	Cab	Pac	Gas						DIS	DATE	PART NO.
①				0~6	0.1	0.1	0.1	0.2	0.5	1	0.5	0.2	PHILP	PHILP	TREE	2016-05-6	PART NO.	11.99.5795, 11.99.5796, 11.99.5797	ROO
②				6~30	0.1	0.1	.15	.25	1	1	0.5	.25							
③				30~80	0.1	.15	0.2	0.3	2	1.5	1	0.3							
④				80~180	.15	.15	.25	0.3	2	2	1	.45							
⑤				180~315	.15	0.2	0.3	0.4	2.5	2	1	0.6							
				315~800	0.2	0.3	0.4	0.5	3	3	2	1.1	SCALE	1:1	UNIT	MM			