



Philips
Professional TV

32" MediaSuite
powered by Android™



32HFL5114

Smarter connectivity

with Chromecast built-in and Netflix

Designed for a fast-paced world, MediaSuite features advanced connectivity and versatile configuration settings. Chromecast built-in makes streaming fast and easy, whilst Android™ and Google Play Store unleash infinite possibilities.

Ready for anything

- Chromecast built-in . Cast content to the big screen
- Integrated Netflix with dedicated remote button
- Google Assistant™ enables faster, smarter control
- Android updates provide the latest functionality
- Google Play Store access for apps and media
- Customisable UI for custom logos and colours
- Analogue clock display in off mode
- Chromecast™ built-in for easy content sharing

Powered for more

- Instant initial cloning for faster installation
- Operate, monitor and maintain via CMND & Control
- Create custom experiences with CMND & Check-in
- Analytics on-board provides usage stats
- Install and manage apps remotely with AppControl

PHILIPS

Highlights

Powered by Android

Android-powered Philips Professional TVs are fast, versatile and easy to navigate. The TVs are optimised for native Android apps and you can install web apps directly to the display too. Automatic updates ensure apps stay up to date.

Google Play Store access

Full access to the entire Google Play Store makes it easy to add apps, games, music, movies, and more to your Philips Professional Display. New business tools and extra entertainment options are added to the catalogue daily, ensuring that you always have access to the latest global trends.

Customisable UI

Philips MediaSuite features a clear, easy-to-navigate user interface (UI) that can be customised with your own branding. Easily add your logo and colours to the search bar to increase the presence of your brand.

Analytics on-board

From hotel chain to sports bar, monitor how each Android-powered Philips MediaSuite TV in your fleet is being used. Find out how often specific channels are watched. Test the effectiveness of your advertising. Get the information you need to manage costs effectively, with easy access to screen-time data. Launch instant customer satisfaction

surveys for valuable feedback from guests on the spot.

AppControl

Take full, centralised control of the apps installed on your Philips Professional TVs. AppControl lets you install, delete, and manage apps on selected TVs or your entire network so that you can offer personalized experiences to your guests and customers-no matter how many TVs you are managing.

CMND & Control

Run your display network over a local (LAN or RF) connection. CMND & Control allows you to perform vital functions like updating software and settings, as well as monitoring display status. Whether you're in charge of one TV or more, CMND & Control makes managing your fleet easy.

CMND & Check-in

Make visitors feel welcome. CMND & Check-in lets you use individual information-such as name and language spoken-to create a personalized experience. Whether you're adding special touches for hotel guests, streamlining the billing process, or offering multiple channel packages.

Integrated Netflix

Integrated Netflix access makes watching the latest movies and shows from your account

easier, faster and more convenient. There's no need for any external players or satellite TV, which helps keep operational costs down and installations neat, whilst maintaining a modern look for your establishment. A dedicated Netflix button on the remote provides instant access for efficient usability. Terms and conditions apply for Netflix activation.

Google Assistant™

Voice control and faster answers are here with the optional Google Assistant™ enabled remote control (22AV2025B/00). Open YouTube. Turn the volume up. Play your favourite songs, and get all the info you need such as weather updates, things to do, and even spoken translations in an instant. With Google Assistant™, the possibilities are endless.

Chromecast built-in

Enable instant, secure wireless casting of movies, presentations, and more from smart devices (mobiles, laptops, tablets) in up to 4K resolution. Chromecast is cost-effective, requires no extra hardware, and is secure for professional use. Users simply tap the Chromecast icon on their smart device to start streaming content from thousands of cast-enabled apps-their smart device becomes the remote.

Specifications

Picture/Display

- Display: LED Full HD
- Diagonal screen size: 32 inch / 80 cm
- Panel resolution: 1920x1080p
- Brightness: 250 cd/m²

Audio

- Sound output Power: 16 (2x8) W
- Speakers: 2.0, Down Firing
- Bathroom speaker out: 1.5W Mono 8Ohm
- Sound Features: DTS-HD, Dolby Atmos Compatible, Dolby MS12D, AC-4, DTS Studio Sound

Design

- Colour: Black

Android TV

- Memory size(Flash): 16GB*
- OS: Android TV™ 9 (Pie)
- Pre-installed apps: Netflix*, YouTube, Google Play Store*, Google Play Movies, Google Play Games, YouTube Music

Tuner/Reception/Transmission

- Digital TV: DVB-T/T2/C, HEVC FHD (up to 1080p60)
- Analog TV: PAL
- IP Playback: Multicast, Unicast, HLS, OTT App Channels

Wireless Connectivity

- Wireless LAN: 802.11 ac, Wifi-Direct

Connectivity Rear

- Digital Audio out: Optical
- Ethernet (LAN): RJ-45
- Antenna: IEC-75
- External power: 12V, max 1.5A
- External Control: RJ-48
- HDMI2: HDMI 1.4
- USB2: USB 2.0
- Bathroom speaker out: Mini-Jack

Connectivity Side

- Common Interface Slot: CI+ 1.3.2
- USB1: USB 3.0
- HDMI1: HDMI 1.4
- Headphone out: Mini-Jack

Connectivity Enhancements

- HDMI: ARC (all ports), Auto Input Selection
- EasyLink (HDMI CEC): One touch play, System Standby, RC pass through, system audio control
- RJ48: IR-In/Out, Serial Xpress interface

Hospitality Features

- Sharing: Chromecast built-in, Secure Sharing, Network-managed Sharing
- Your brand: Customizable Home Screen, Customizable Welcome App, Location Name (Geonames ID), CMND&Create, Custom Dashboard (HTML&APK)
- Convenience: Google Assistant*, Google Account Login, Weather Forecast, >40 Supported Menu Languages, Clock in OFF mode, Theme TV, Wake Up Alarm, Sleep Timer
- CMND&Control: Off-Line Channel Editor, Off-Line Settings Editor, Remote Management over IP/ RF, TV Group management, Local Updates via USB, Instant Initial Cloning
- CMND&Check-In: Guest Name, Guest Language, Messages, Bill on TV, Express Checkout
- Remote Control: Low Battery Detection, RC Battery Door Lock, Glow-in-the-Dark Clock button
- Control: AppControl, JEDI Native Android TV Control, JSON API for TV Control-JAPIT, Serial Xpress Protocol, Crestron Connected, Joystick
- Interactive DRM: VSecure, Playready Smoothstreaming, Securemedia
- Power control: Quick Start Mode, Auto Power ON, Auto Power OFF
- Revenue generation: MyChoice
- Hotel mode: Switch-ON Settings Control, Volume limitation, Installation Menu Lock, Menu lock, Joystick Control Lock, Prison mode

Healthcare features

- Control: Multi-Remote Control, Nurse call system compatible
- Convenience: TalkBack, Independent main speaker mute
- Safety: Double isolation class II, Flame retardant

Multimedia

- Video playback supported: Formats: H.264/MPEG4 AVC, MPEG1, MPEG2, MPEG4, WMV9/VC1, HEVC, Containers: AVI, MKV, VP9
- Subtitle formats supported: SRT, SMI, TXT

- Music formats supported: MP3, AAC, WAV, WMA (v2 up to v9.2), WMA-PRO (v9 and v10)
- Picture formats supported: JPG, PNG, BMP, GIF
- Supp. Video Resolution on USB: up to 1920x1080p@60Hz

Accessories

- Included: Edge Stand, Remote Control 22AV1905B/00, 2xAAA Batteries, Power Cord, Warranty Leaflet, Legal and Safety brochure
- Optional: Voice RC 22AV2025B/00, Digit RC 22AV2005B/00, Easy RC 22AV1601B/12, Healthcare RC 22AV1604B/12, External Clock 22AV1860A/12, DOCSIS Cable Modem 22AV1970A, Setup RC 22AV9574A/12

Power

- Mains power: AC 220-240V; 50-60Hz
- Energy Label Class: F
- EPREL registration number: 341818
- Eu Energy Label power: 29 W
- Standby power consumption: <0.35W
- Power Saving Features: Eco mode
- Ambient temperature: 0 °C to 40 °C

Dimensions

- Set dimensions (W x H x D): 732 x 432 x 77 mm
- Set dimensions with stand (W x H x D): 732 x 494 x 179 mm
- Product weight: 4,6 kg
- Product weight (+stand): 4,7 kg
- VESA wall mount compatible: 100 x 100 mm

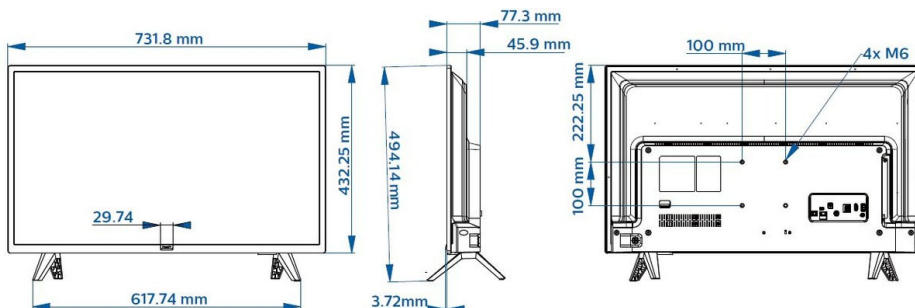

Issue date 2021-02-26

Version: 3.0.2

12 NC: 8670 001 66832
EAN: 87 18863 02385 3

© 2021 Koninklijke Philips N.V.
All Rights reserved.

Specifications are subject to change without notice.
Trademarks are the property of Koninklijke Philips N.V.
or their respective owners.

www.philips.com

* Netflix: specific terms and conditions apply which have to be approved and applied in order to enable the app.
* Availability of Google Assistant is depending on Country and Language settings. To use Google Assistant, an optional remote control with voice function must be used.
* Availability of features will depend on implementation chosen by integrator.
* Philips does not guarantee the availability or continuity of correct functioning of apps.
* Actual free memory may be less due to device pre-configuration
* Typical on-mode power consumption measured according to IEC62087 Ed 2. The actual energy consumption will depend on how the television is used.
* This television contains lead only in certain parts or components where no technology alternatives exist in accordance with existing exemption clauses under the RoHS Directive.
* Android, Google Play and Chromecast are trademarks of Google LLC